

# WEO®

---

**GUIDE TECHNIQUE**



**Fiberdeck®**



WEO® est un bardage en bois composite  
co-extrudé à faux claire-voie

---

Son profil trapézoïdal permet aussi bien  
une pose horizontale que verticale

WEO® se caractérise par un bois composite de dernière génération issu de la co-extrusion. Les lames sont protégées par un film en polyéthylène qui enrobe toute leur surface et garantit ainsi toute reprise d'humidité. Il est de plus insensible aux taches et à la décoloration.



# PROFILS & ACCESSOIRES



## WEO® 35

Lame de bardage composite coextrudée  
33 x 170 x 3600 mm | 7,52 kg (pce)  
(Surface utile = 0,504 m<sup>2</sup>)



Teak  
Réf 0942



Argent  
Réf 0944



Ipé  
Réf 0943



Ardoise  
Réf 0945



## WEO® 60

Lame de bardage composite coextrudée  
33 x 170 x 3600 mm | 7,52 kg (pce)  
(Surface utile = 0,504 m<sup>2</sup>)



Teak  
Réf 1078



Cedre  
Réf 1080

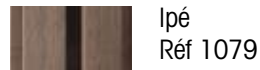

Ipé  
Réf 1079



Ardoise  
Réf 1081



Vis inox SR2 - boîte de  
500 pcs + embout  
4,2 x 38 mm | 4,00 kg (pce)



Teak  
Réf 0946



Ardoise  
Réf 0949



Ipé  
Réf 0947



Cedre  
Réf 1196



Argent  
Réf 0948



Vis Bardage WEO® 60  
Fixation invisible  
4.2 x 32mm | 500pcs + embout

Réf. 1337



Profil F (2 pcs)  
65 x 80 mm x 3,60 m  
4,00 kg (pce)



Teak  
Réf 0967



Ardoise  
Réf 0970



Ipé  
Réf 0968



Cedre  
Réf 1428



Argent  
Réf 0969



# LES 10 POINTS ESSENTIELS



## 1 STOCKAGE ET MANIPULATION

**Le bois composite est une matière sensible au fluage.**

- > Il est impératif de stocker les lames toujours à plat. Lors de l'entreposage des palettes de lames, veillez à bien les faire reposer sur toute leur longueur.
- > Gardez la bâche de protection des palettes pendant les travaux comme protection.
- > Evitez de poser des charges sur les palettes de lames.
- > Portez les lames une à une ou deux par deux sur les chants.

## 2 OUTILLAGE

- > Scie radiale pour tronçonnage posée sur table
- > Visseuse équipée d'un embout de type SR2 (embout fourni dans la boîte de vis)



## 3 TASSEAUX

- > Pose horizontale : Liteaux calibrés Classe 2 de section minimum 30 x 40 mm.
- > Pose verticale : Liteaux calibrés Classe 2 de section minimum 30 x 40 mm à drainage rapide ou Classe 3.
- > Double liteaux a chaque jonction de lames ou liteaux calibrés Classe 2 de section minimum de 30 x 60 cm.
- > Espacement des tasseaux : 60 cm.

## 4 DÉCOUPE

- > Chaque lame doit être calibrée avant la pose. Elles peuvent avoir une surcote de 10 mm. Ils est donc important de les recouper à la dimension souhaitée pour avoir des joints propres





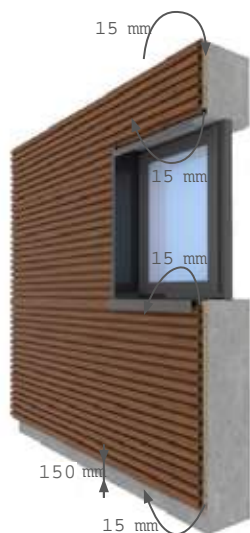

## 5 VENTILATION

- > Garde au sol : 150 mm.
- > Ventilation haute et basse (acrotère, tapée & linteau de fenêtre 15 mm).
- > lame d'air entre mur et parement : 20 mm minimum

## 6 FIXATION SUR SUPPORT BOIS

Vis auto-perceuse inox 304 - 4,2 x 38 mm  
- filetage bois/aluminium.

- > Couleur de la vis coordonnée à la couleur du bardage.
- > Empreinte = SR2.
- > Tête Ø 8.0 mm.
- > Corps de diamètre Ø 4,2 mm.
- > Longueur sous tête : L = 38 mm.
- > Pointe auto-perceuse.
- > Crantage anti-foirage sous tête.

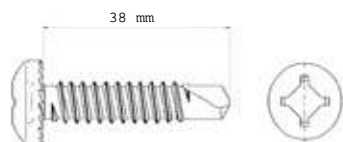
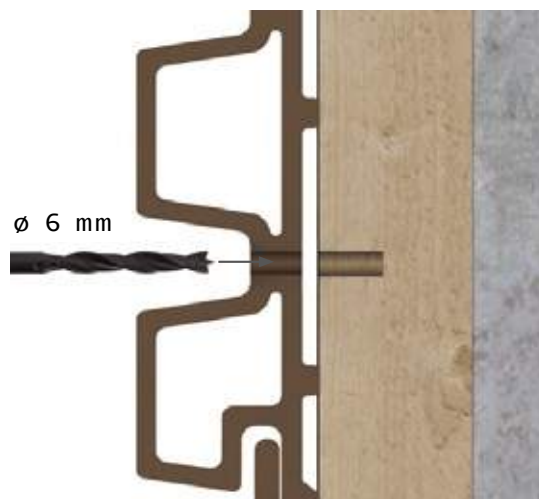

1 - Percage Ø 6 mm.

2 - Prévoir une vis par lame dans un seul fond de gorge en partie courante. Entraxe 600mm.

Prévoir 2 vis à chaque extrémité pour le WEO® 35.

Attention la tête de vis doit venir en appui sur la lame de bardage, mais sans effort, au risque de créer une amorce de fissure. En bout de lame, prévoir un retrait de 15 mm pour éviter tout risque de fissure.

3 - WEO® 60 - En pose verticale : prévoir un vissage dans la gorge de la languette basse pour une fixation invisible par vis 4,2 x 32 mm - Réf. 1337



WEO® 35



WEO® 60

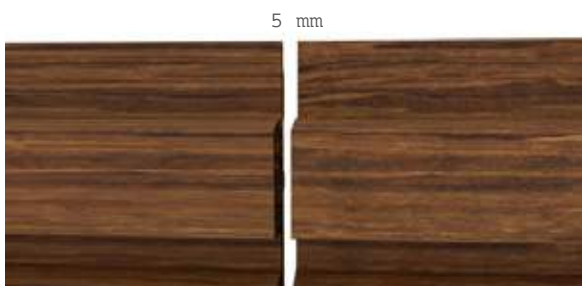
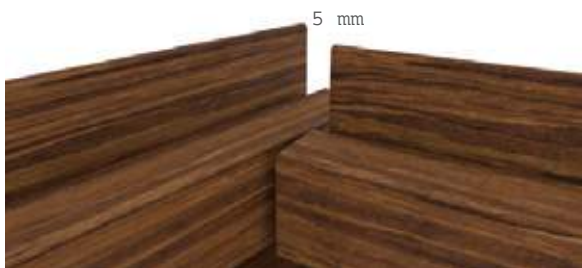

## 7 DILATATION

> Les lames WEO® ont un coefficient de dilatation de 1 mm/ml (pour un gradient de température de 40°C) Exemple : une lame de 3,6 m rencontrant une température de 5°C le matin et 40°C l'après midi aura une dilatation de 3,15 mm.

> Respecter entre chaque extrémité de lame et tous les types d'obstacles rencontrés (menuiserie, mur, angle, lame ..) un jeu de 5 mm.

## 8 SENS DE POSE DES LAMES WEO® 35 / WEO® 60

### Pose à l'horizontale :

- > La rainure est en position basse et la languette en position haute.
- > 2 vis dans 2 ondes pour la première lame en partie basse.

### Pose à la verticale :

- > Pas de sens particulier.



## 9 FINITIONS

- > Nous conseillons l'utilisation de profils en aluminium laqué pour réaliser les finitions.
- > L'ensemble des profils de finition nécessaires à réaliser (les cornières d'angles rentrant et sortant, les abouts de bardage, profil sous bardage, tableau de menuiserie, joint de dilatation vertical ou horizontal) est détaillé dans ce guide de pose.
- > Les plans sont fournis selon les caractéristiques à respecter, et certains éléments ont des dimensions variables à adapter en fonction de l'ouvrage. Les profils doivent être fabriqués à la demande chez des spécialistes du pliage de tôle fine et en tenant compte des particularités de l'ouvrage.

## 10 VIEILLISSEMENT & ENTRETIEN

Le film protecteur en polyéthylène issu du procédé de co-extrusion garantit une tenue aux UV de 20 ans sans décoloration apparente. Un nettoyage à l'eau (nettoyeur haute pression) peut être réalisé selon l'exposition des façades et des dépôts de saletés.

# PROFILS & ACCESSOIRES

## 1 - DESCRIPTIF DU BARDAGE WEO®

Le bardage WEO® est un système de bardage rapporté à faux claire-voie, conforme à la norme EN 15534. Il est conçu en bois reconstitué, composé de 50% de fibres de bois issues de produits connexes d'usine de seconde transformation du bois et de 50% de polyéthylène recyclé.

Il présente en surface un aspect mat brossé, avec une pigmentation multi-chromatique.

Les lames de bardage WEO® 35 sont composées de 3 ondes de 36 mm. Elles sont proposées dans 4 couleurs : Ipé, Teak, Ardoise, Argent.

Les lames de Bardage WEO® 60 sont composées de 2 ondes de 59 mm. Elles sont proposées dans 4 couleurs : Ipé, Teak, Ardoise, Cedre.

Elles peuvent être posées en position horizontale ou verticale sur des parois planes. La fixation se fait en fond d'onde par vis avec tête laquée, teintée sur le RAL approchant de type SFS. WEO® 60 en pose verticale, se fixe dans la gorge de la languette bosse.

Une lame d'air ventilée, de 20 mm minimum, est ménagée entre la face interne des lames et le nu extérieur du mur porteur ou de l'isolant thermique éventuel.

## 2 - CARACTÉRISTIQUES DIMENSIONNELLES

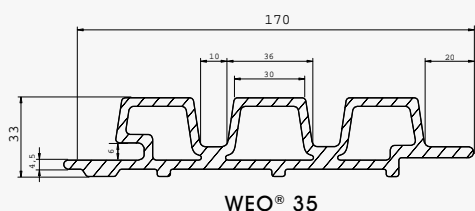

WEO® 35

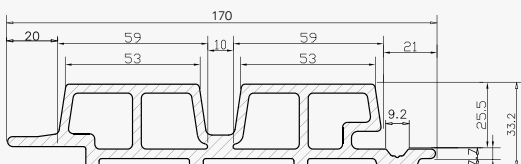

WEO® 60

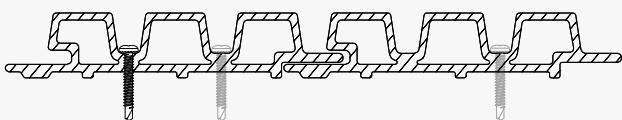

WEO® 35

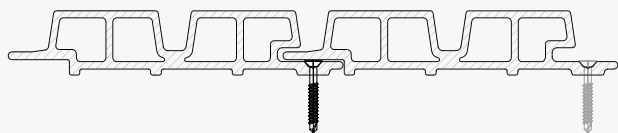

WEO® 60  
POSE VERTICALE

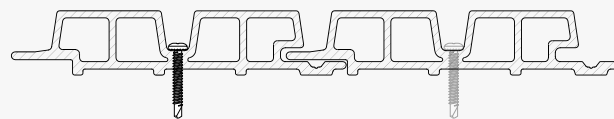

WEO® 60  
POSE HORIZONTALE

Surface d'une lame (utile)	0,504 m <sup>2</sup>
Masse surfacique	15 kg/m <sup>2</sup>
Largeur hors tout	170 mm
Largeur utile	140 mm
Longueur standard	3600 mm

	WEO® 35	WEO® 60
Nombre d'ondes par lame	3	2
Longueur totale de l'onde	46 mm	59 mm
Largeur faux claire-voie	30 mm	53 mm
Profondeur des ondes	20 mm	20 mm

	Nb de vis /m <sup>2</sup>	Nb de Vis / lame de 3,6 m
Entraxe 60 cm	16	7

---

**1 - GAMME 09**

---

**2 - POSE VERTICALE  
SUR TOUS SUPPORTS WEO<sup>®</sup> 35 10**

- Vue Générale
- Pied de mur et Acrotère
- Linteau et tablette
- Tableau métal menuiserie
- Angle sortant
- Angle rentrant
- Joint horizontal
- Fractionnement et coupure lame d'air
- About de bardage
- Joint de dilatation vertical
- Remplacement de lame

---

**3 - POSE HORIZONTALE  
SUR TOUS SUPPORTS WEO<sup>®</sup> 35 21**

- Vue Générale
- Pied de mur et Acrotère
- Linteau et tablette
- Tableau métal menuiserie

- Angle sortant
- Angle rentrant
- Joint Vertical
- Fractionnement et coupure lame d'air
- About de bardage
- Joint de dilatation vertical
- Remplacement de lame

---

**4 - POSE SUR  
CONSTRUCTION  
OSSATURE BOIS WEO<sup>®</sup> 35 32**

---

---

**5 - POSE SUR  
OSSATURE  
METALLIQUE WEO<sup>®</sup> 35 33**

---

---

**6 - POSE BARDAGE WEO<sup>®</sup> 60 35**

- Vue Générale
- Pied de mur et Acrotère
- Remplacement de lame
- Compatibilité profil Weo<sup>®</sup> 35 / Weo<sup>®</sup> 60





# 1- GAMME

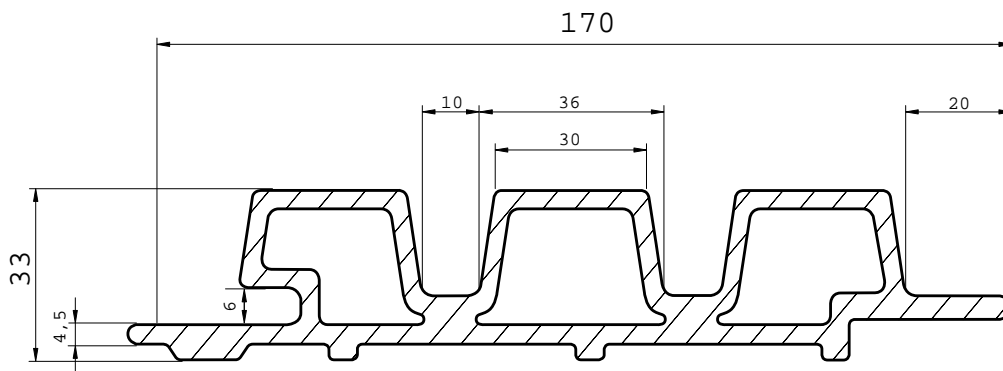

WEO® 35

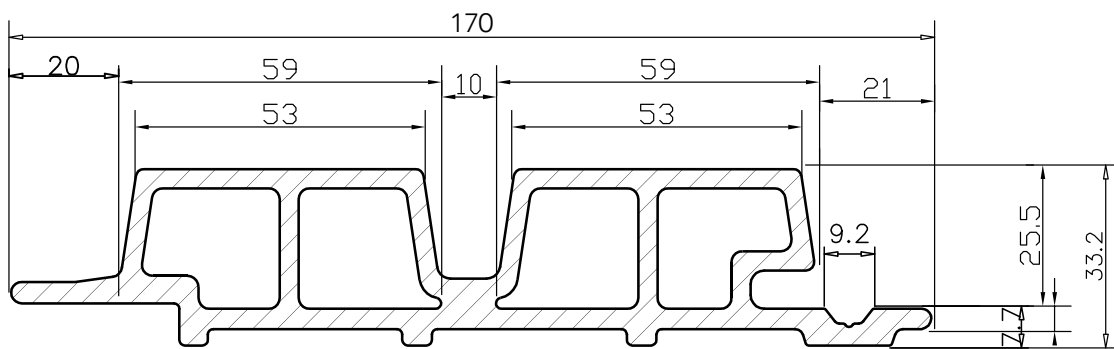

WEO® 60

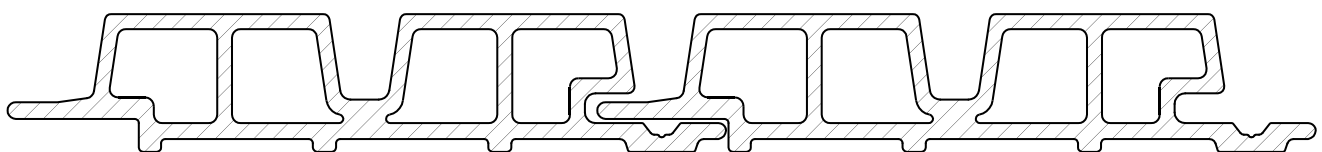
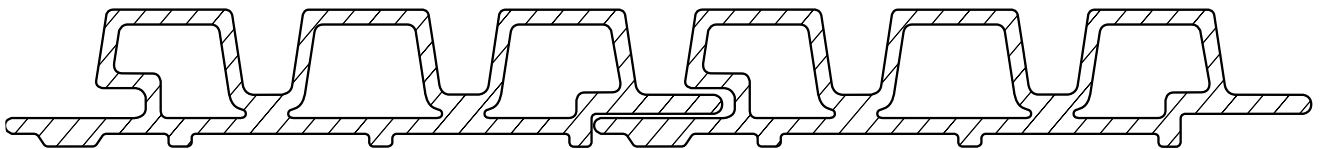

## 2 - POSE VERTICALE SUR TOUS SUPPORTS WEO® 35

### 2.1 - VUE GÉNÉRALE



## 2 - POSE VERTICALE SUR TOUS SUPPORTS WEO® 35

### 2.2 - PIED DE MUR ET ACROTÈRE WEO® 35

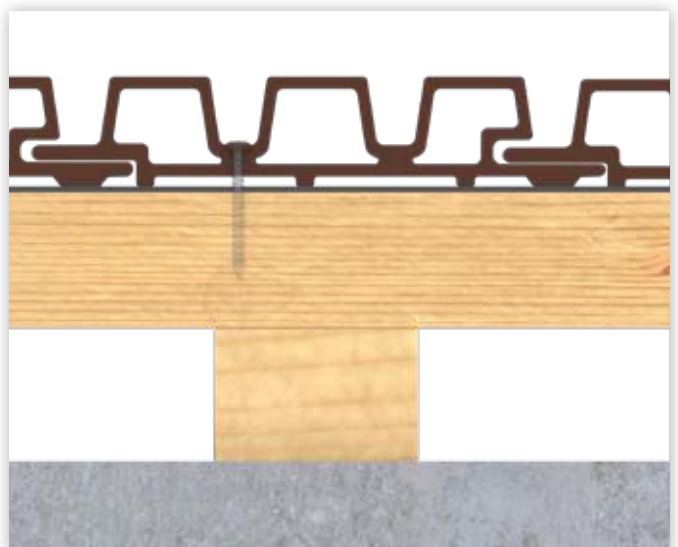
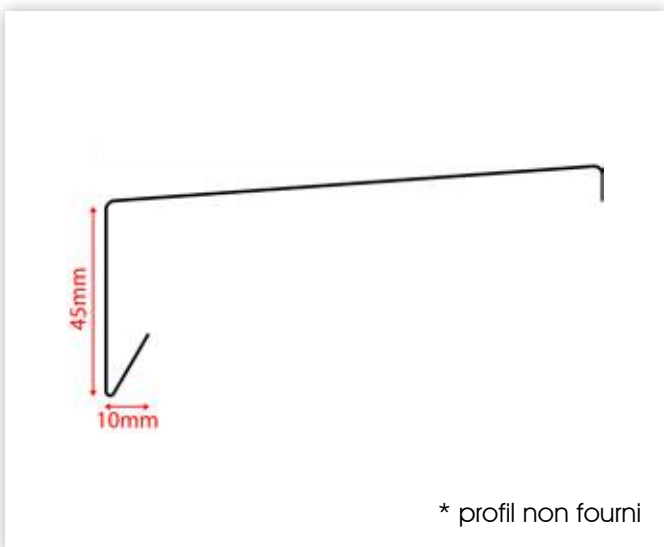
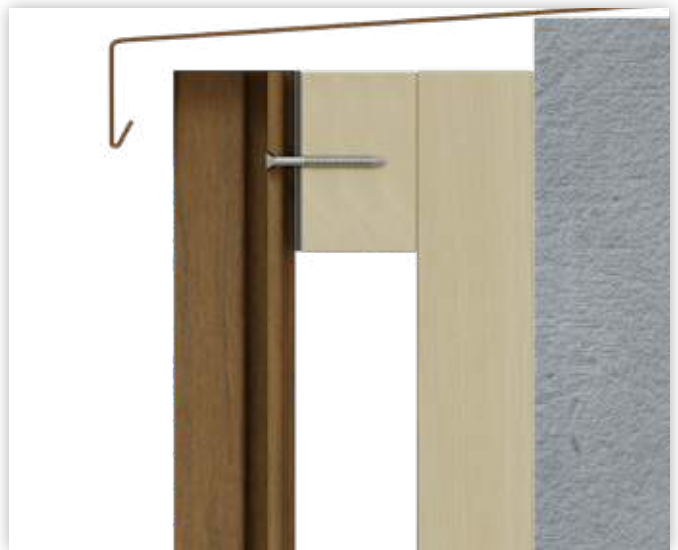
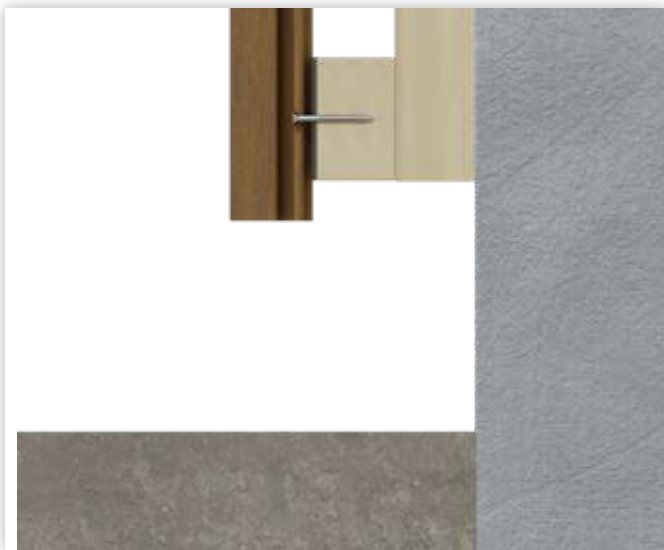

## 2 - POSE VERTICALE SUR TOUS SUPPORTS WEO® 35

### 2.3 - LINTEAU ET TABLETTE

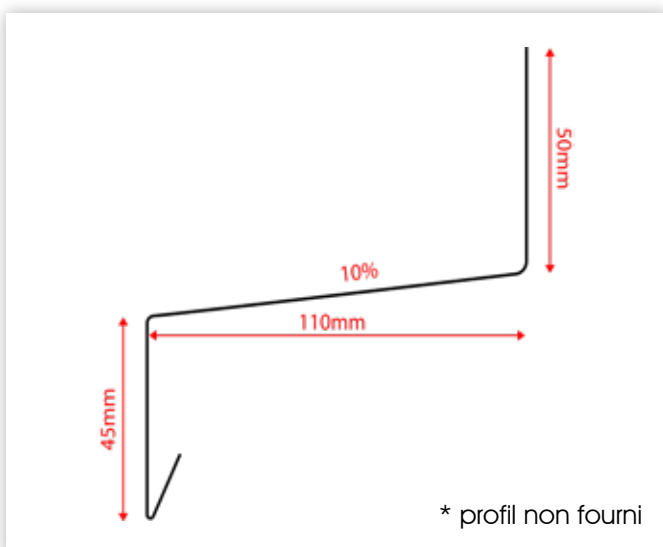
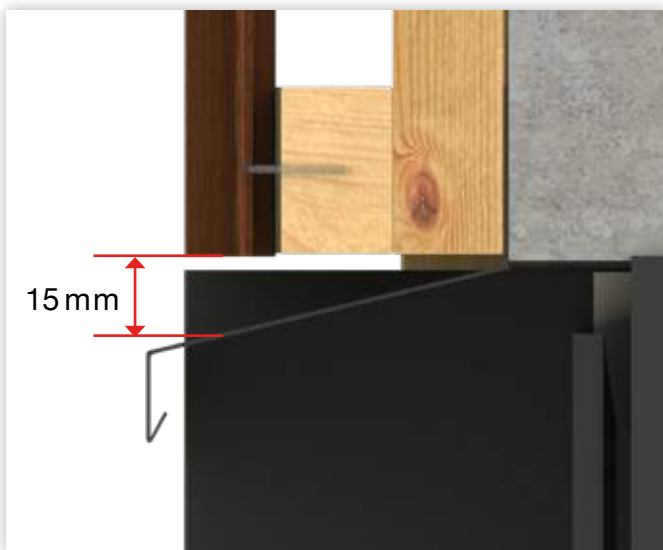
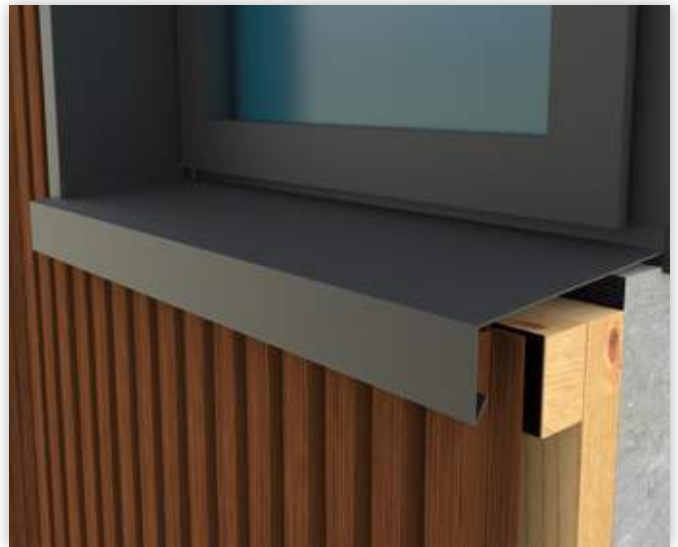
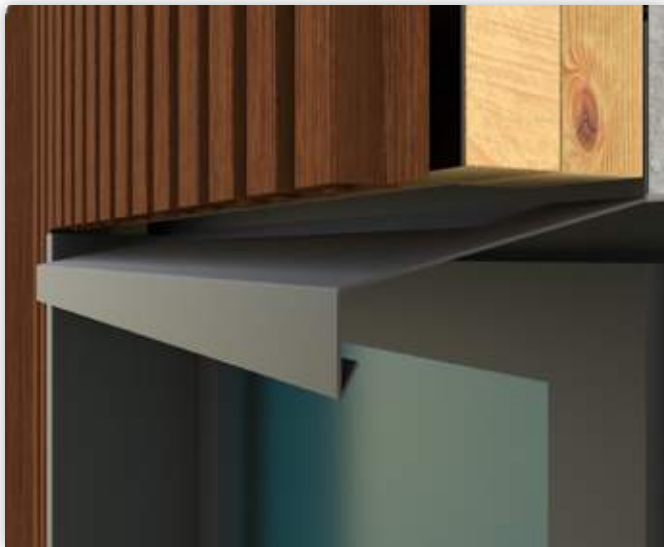

\* profil non fourni

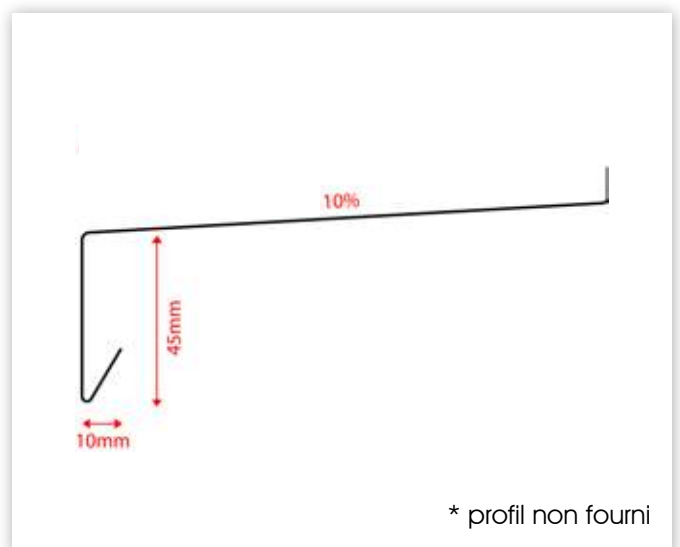

\* profil non fourni



## 2 - POSE VERTICALE SUR TOUS SUPPORTS WEO® 35

### 2.4 - TABLEAU MÉTAL MENUISERIE

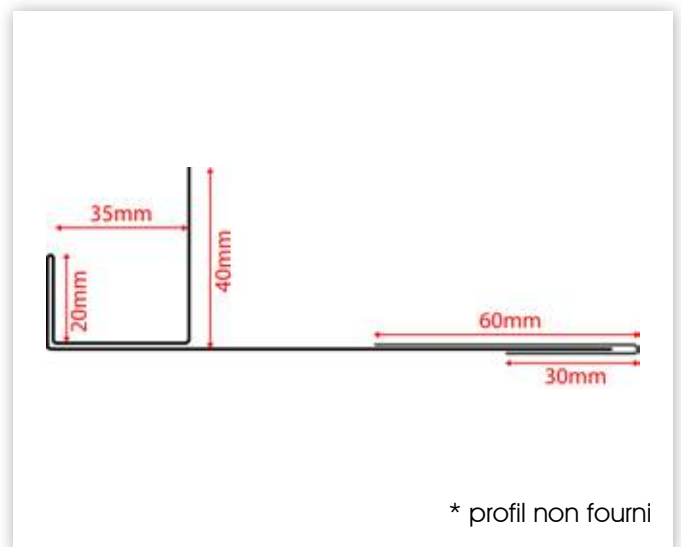
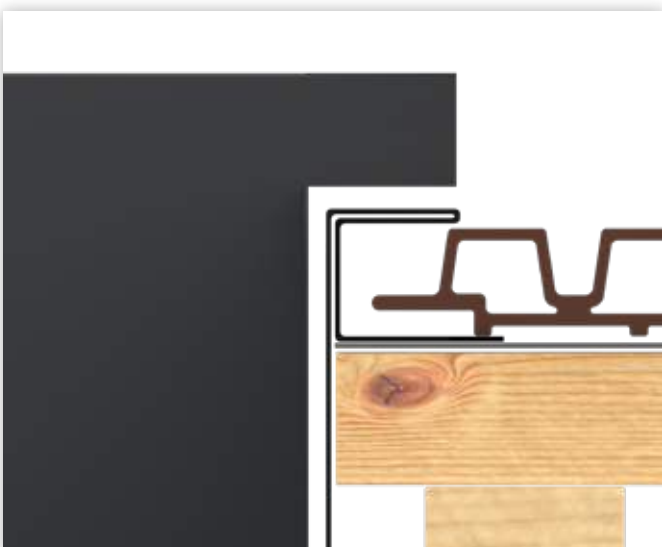

## 2 - POSE VERTICALE SUR TOUS SUPPORTS WEO® 35

### 2.5 - ANGLE SORTANT AVEC COUVRE JOINT

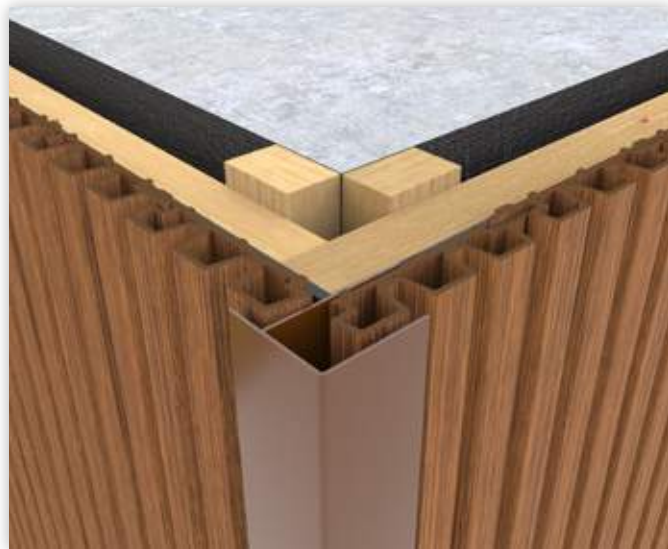

### 2.5.1 - ANGLE SORTANT SANS COUVRE JOINT

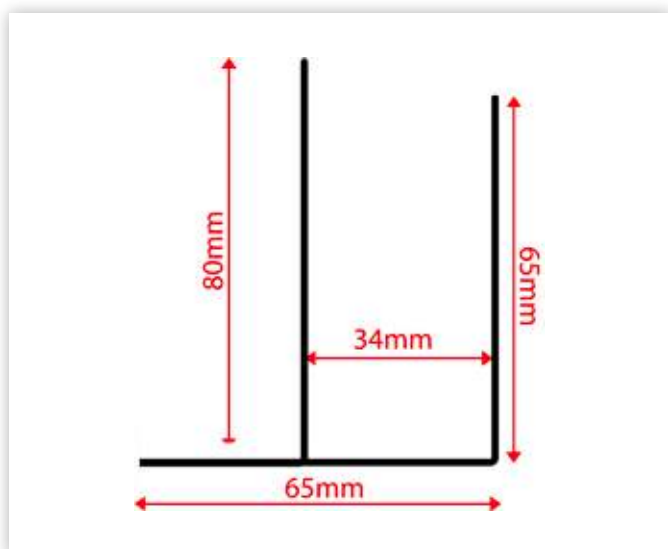
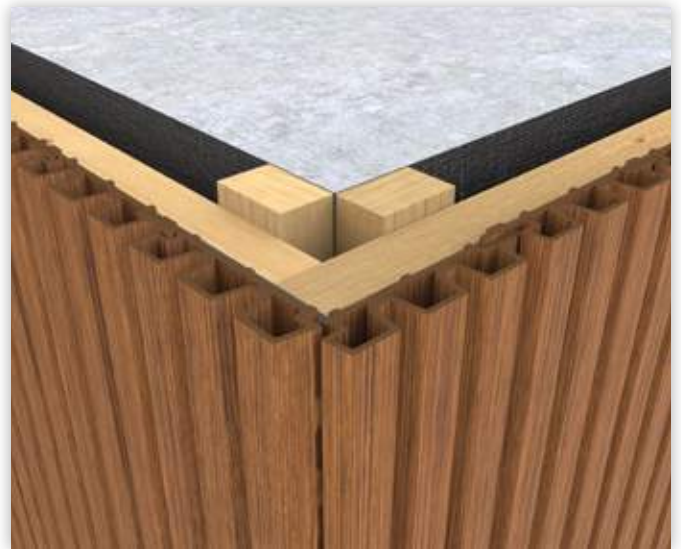

## 2 - POSE VERTICALE SUR TOUS SUPPORTS WEO® 35

### 2.6 - ANGLE RENTRANT AVEC COUVRE JOINT



### 2.6.1 - ANGLE RENTRANT SANS COUVRE JOINT

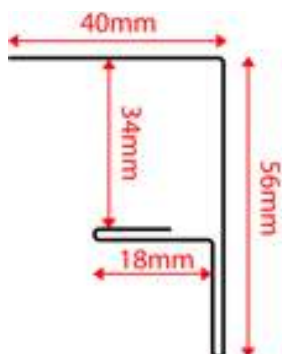
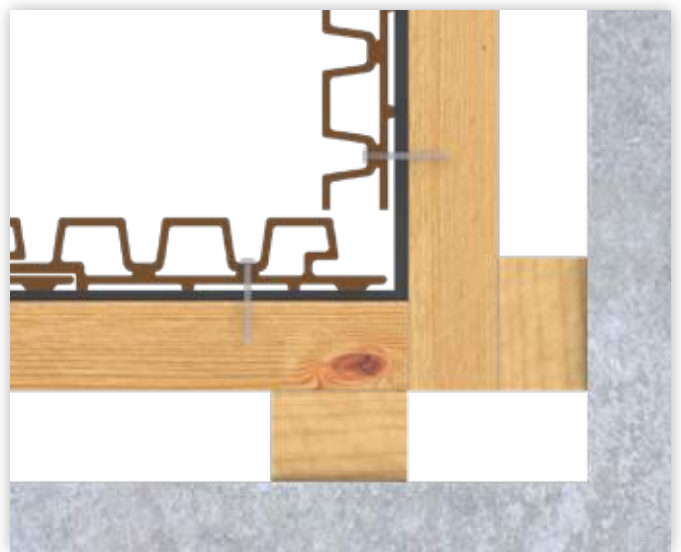
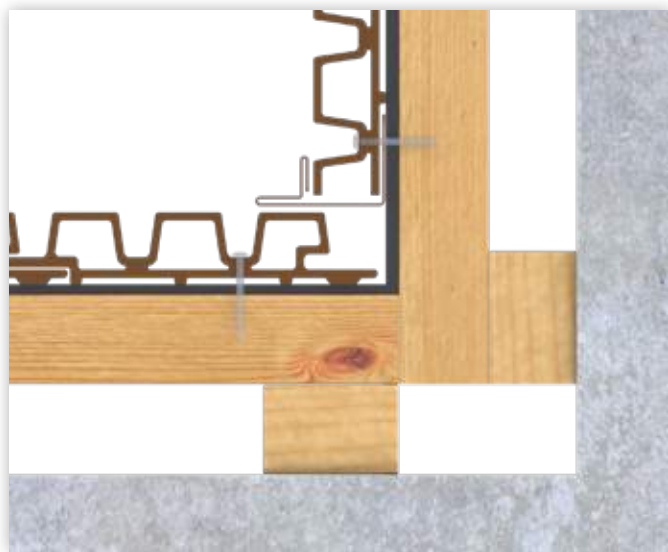

\* profil non fourni





# 2 - POSE VERTICALE SUR TOUS SUPPORTS WEO® 35

## 2.7 - JOINT HORIZONTAL





## 2 - POSE VERTICALE SUR TOUS SUPPORTS WEO® 35

### 2.8 - FRACTIONNEMENT ET COUPURE LAME D'AIR

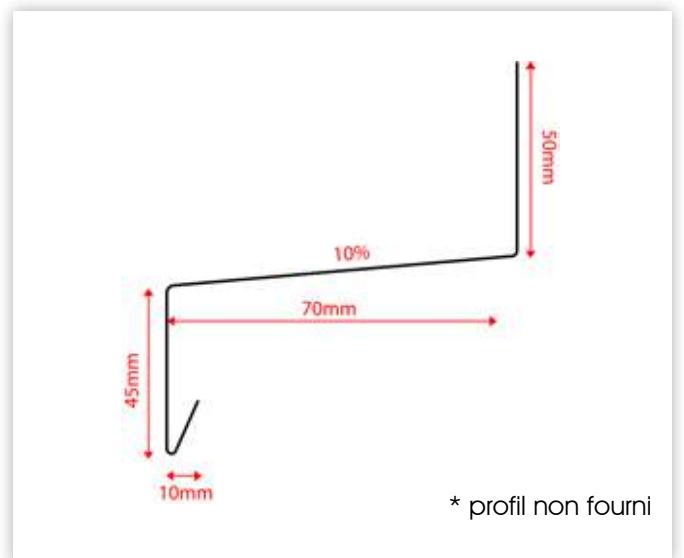
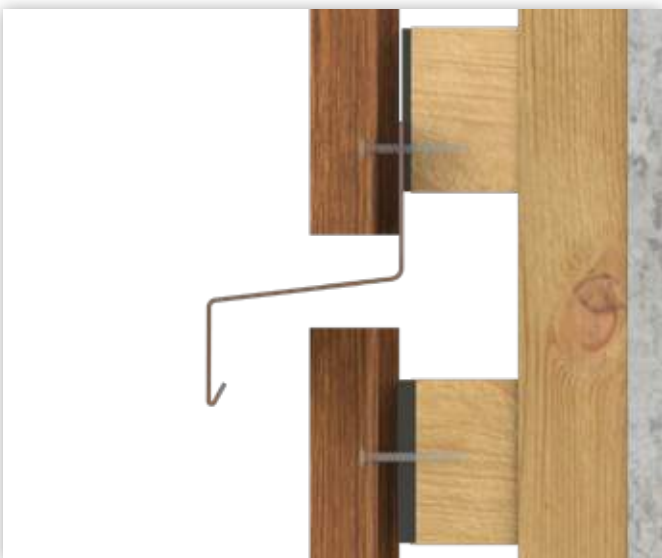

## 2 - POSE VERTICALE SUR TOUS SUPPORTS WEO® 35

### 2.9 - ABOUT DE BARDAGE

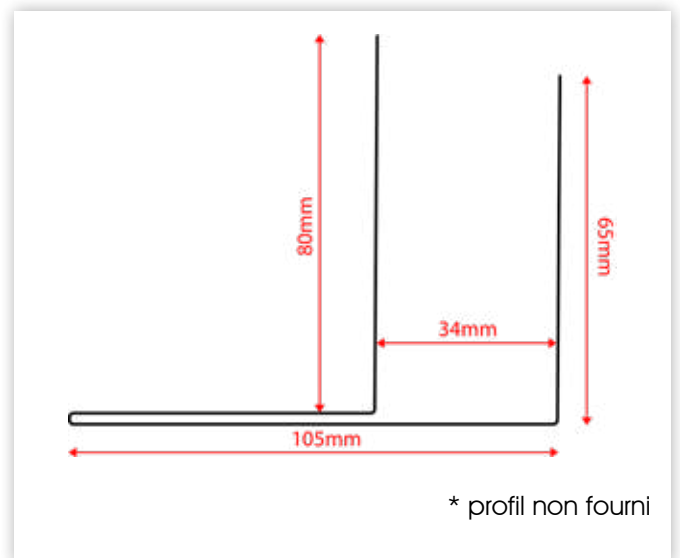
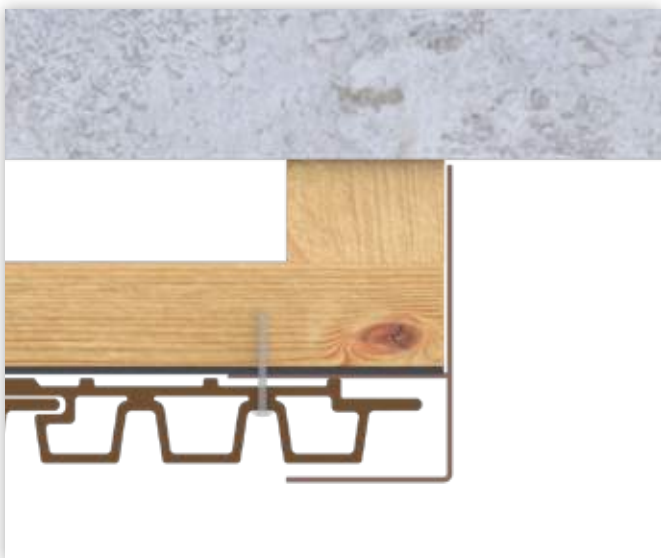

## 2 - POSE VERTICALE SUR TOUS SUPPORTS WEO® 35

### 2.10 - JOINT DE DILATATION VERTICAL

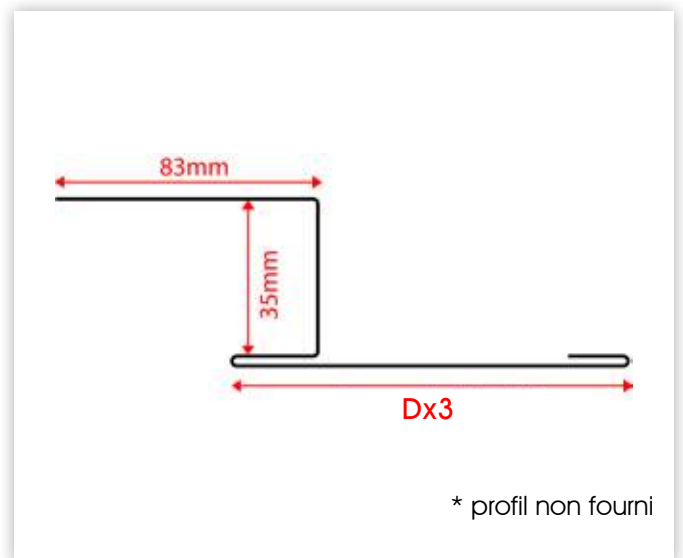
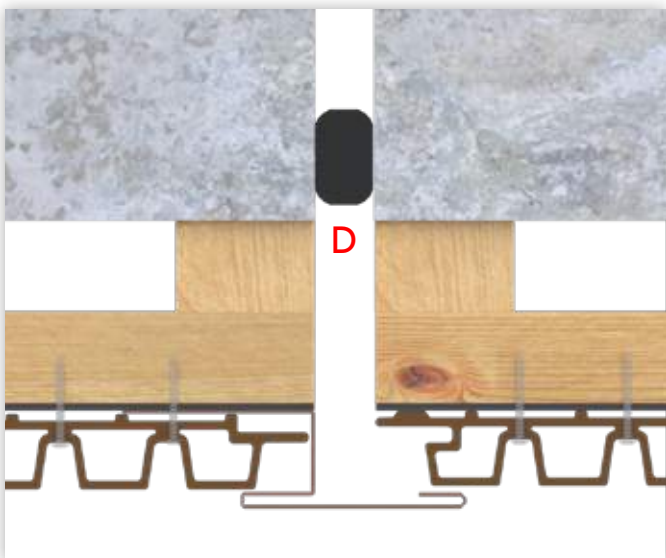



---

## 2 - POSE VERTICALE SUR TOUS SUPPORTS WEO® 35

### 2.11 - REMPLACEMENT DE LAME

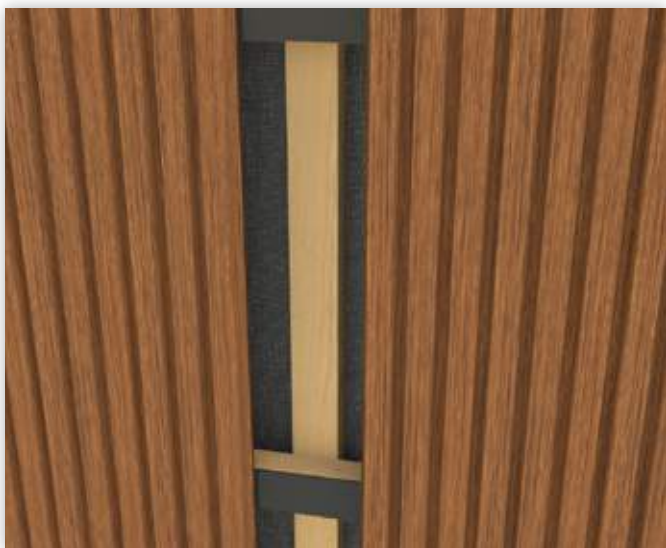
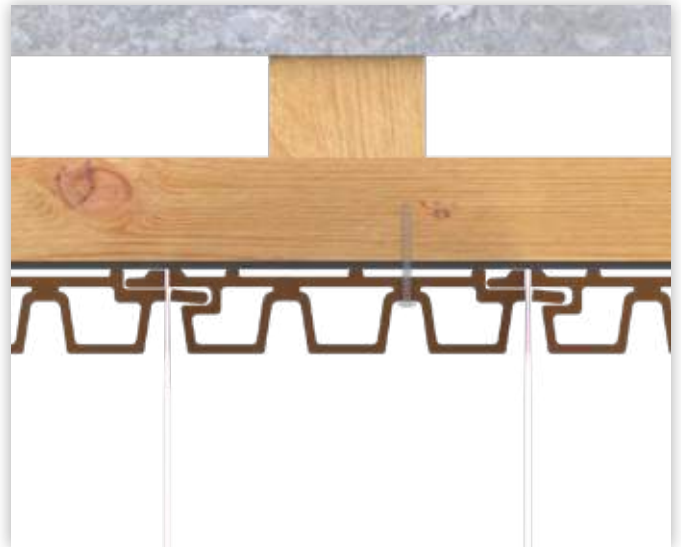



**3 - POSE HORIZONTALE SUR TOUS SUPPORTS WEO® 35**



### 3 - POSE HORIZONTALE SUR TOUS SUPPORTS WEO® 35

#### 3.2 - PIED DE MUR ET ACROTÈRE

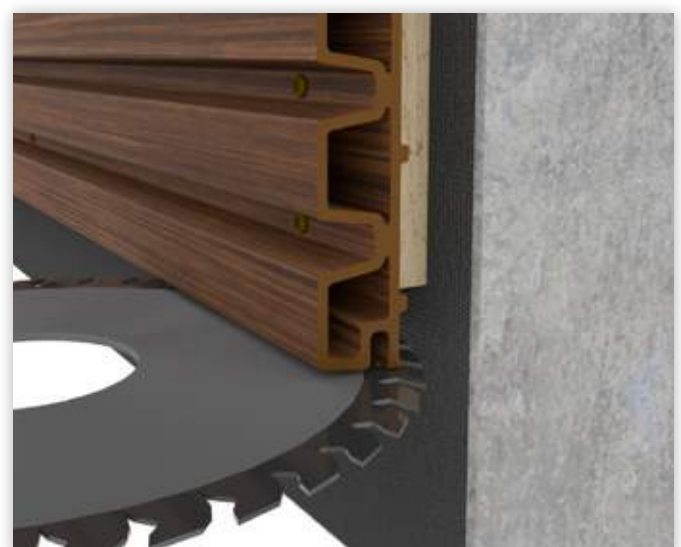
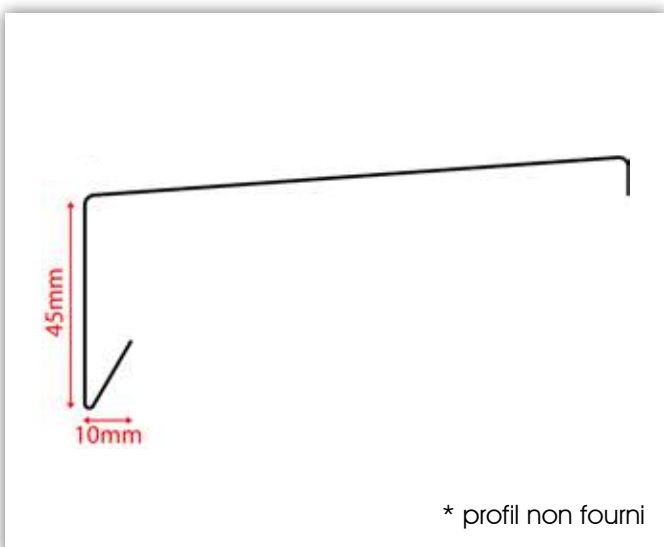
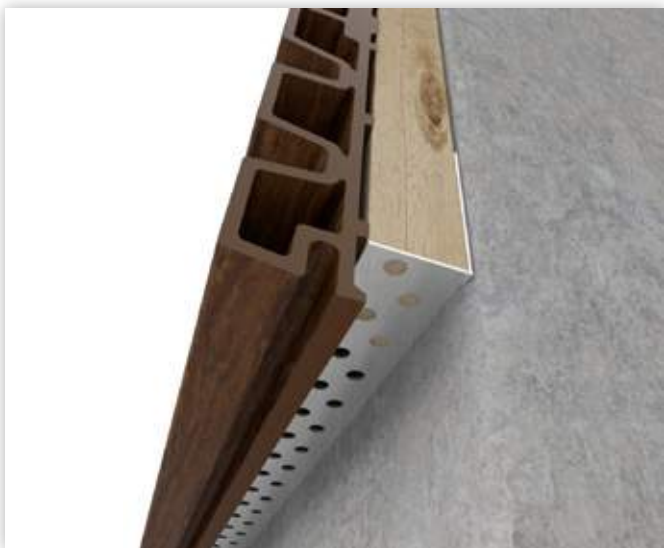
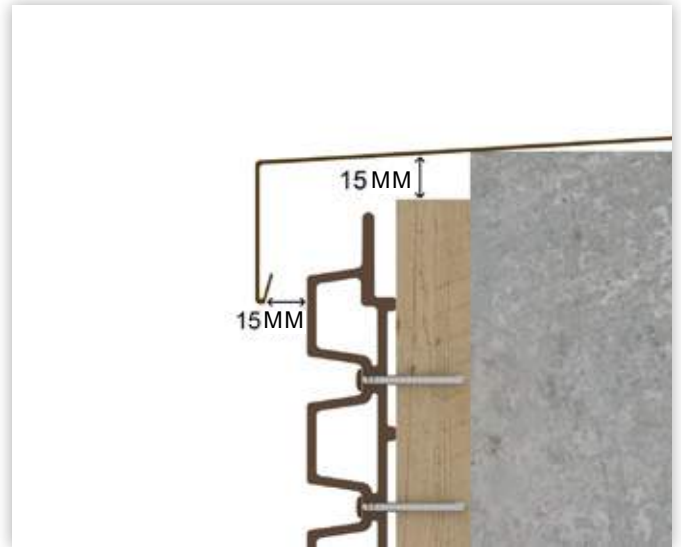

### 3 - POSE HORIZONTALE SUR TOUS SUPPORTS WEO® 35

#### 3.3 - LINTEAU ET TABLETTE

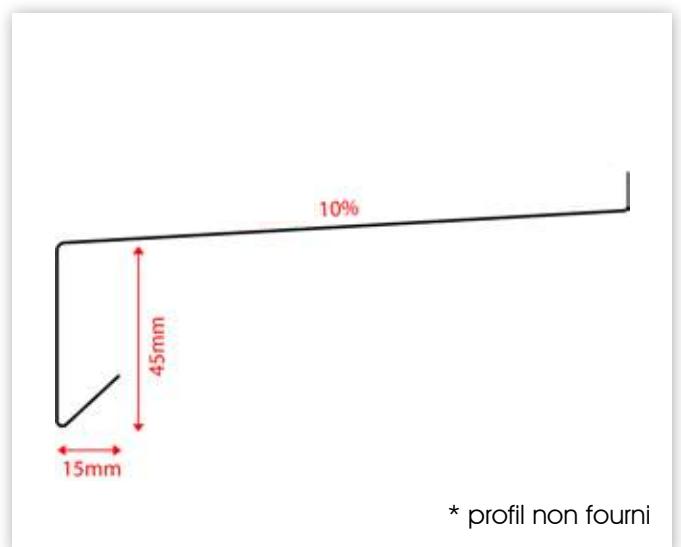
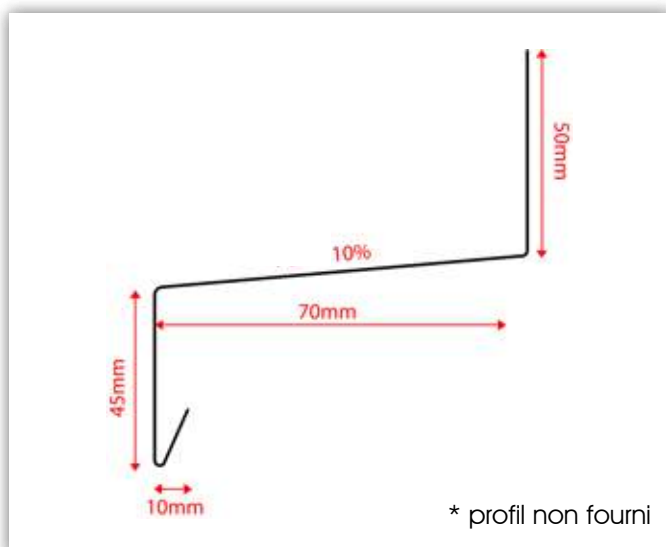

### 3 - POSE HORIZONTALE SUR TOUS SUPPORTS WEO® 35

#### 3.4 - TABLEAU MÉTAL MENUISERIE

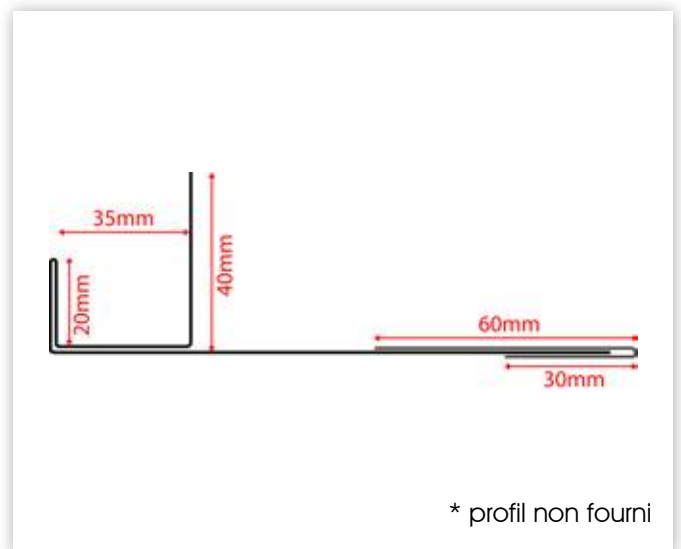



### 3 - POSE HORIZONTALE SUR TOUS SUPPORTS WEO® 35

#### 3.5 - ANGLE SORTANT

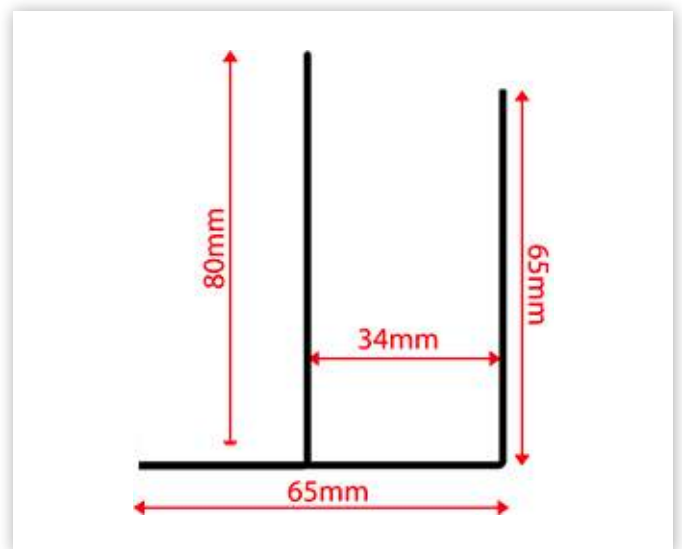
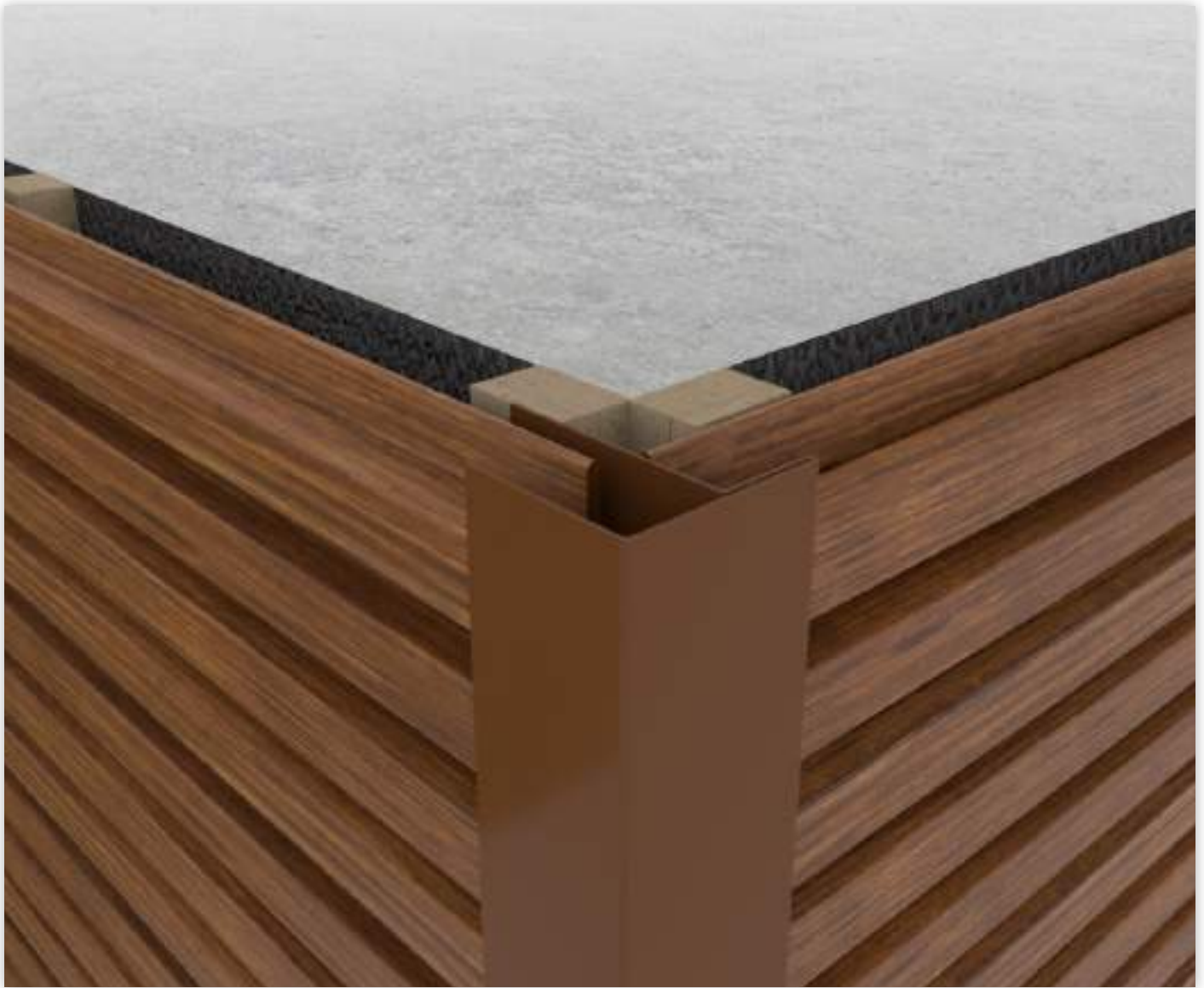

### 3 - POSE HORIZONTALE SUR TOUS SUPPORTS WEO® 35

#### 3.6 - ANGLE RENTRANT AVEC COUVRE JOINT



#### 3.6.1 - ANGLE RENTRANT SANS COUVRE JOINT

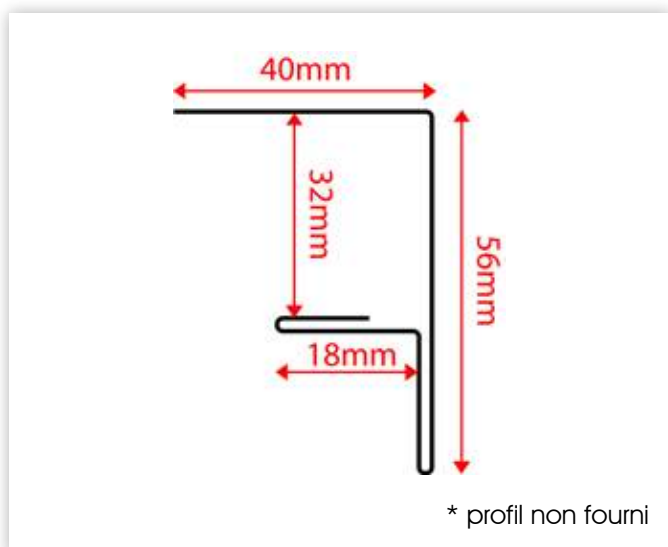
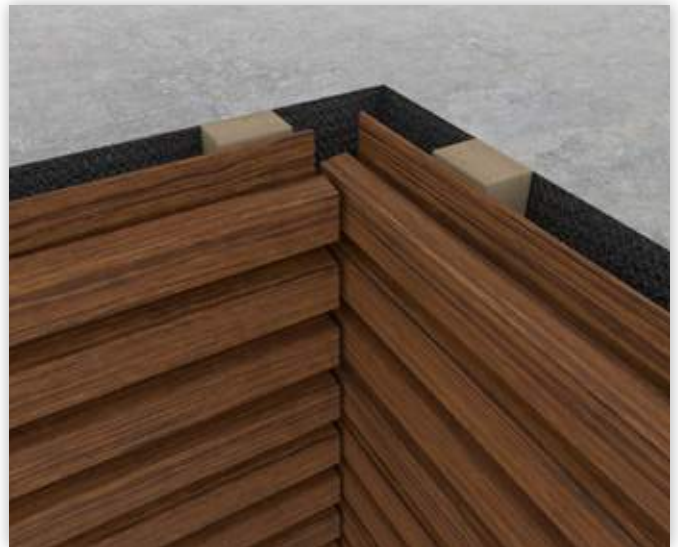

# 3 - POSE HORIZONTALE SUR TOUS SUPPORTS WEO® 35

## 3.7 - JOINT VERTICAL

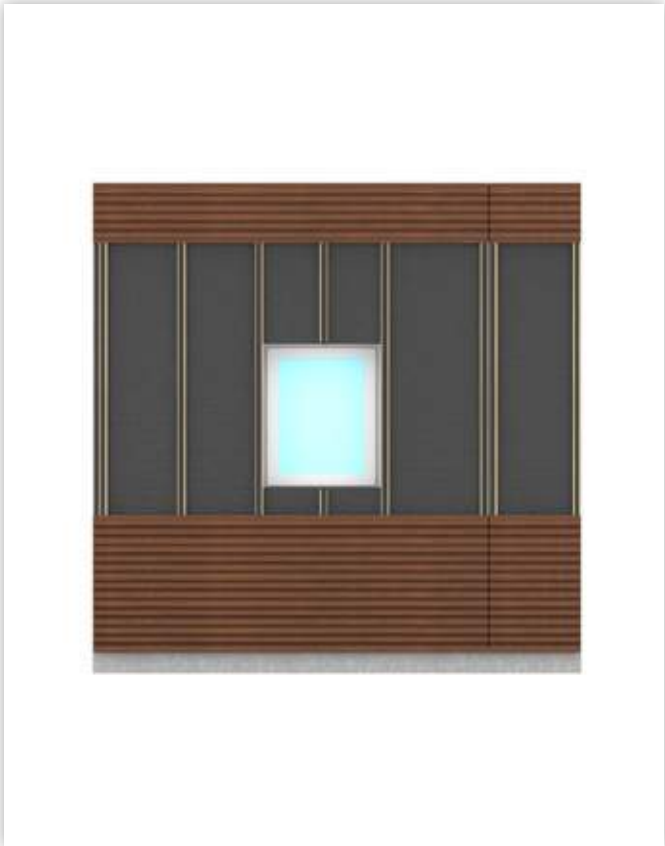
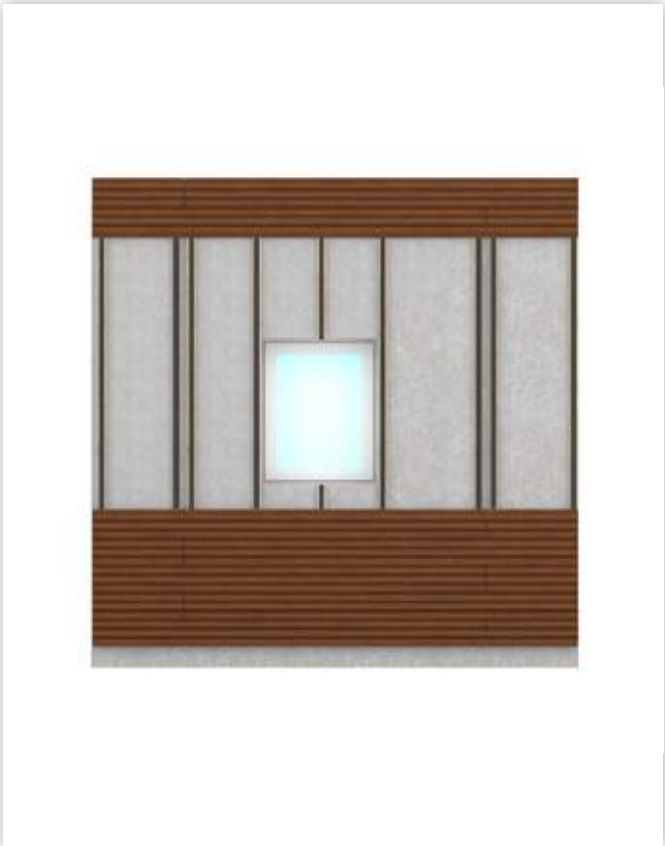

### 3 - POSE HORIZONTALE SUR TOUS SUPPORTS WEO® 35

#### 3.8 - FRACTIONNEMENT ET COUPURE LAME D'AIR

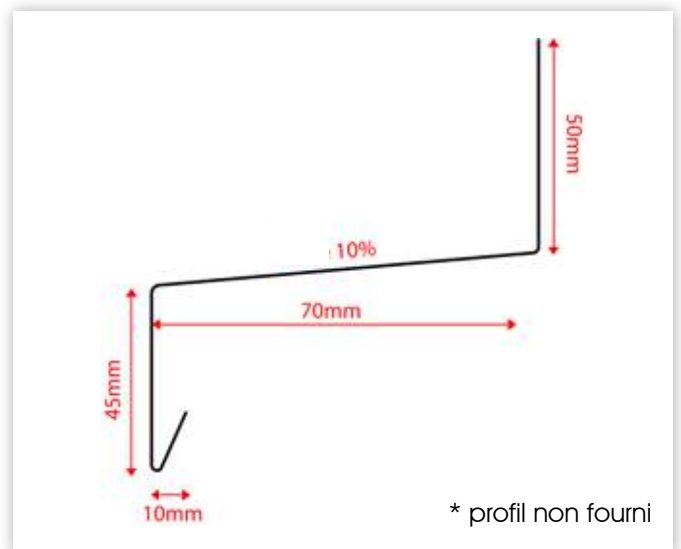
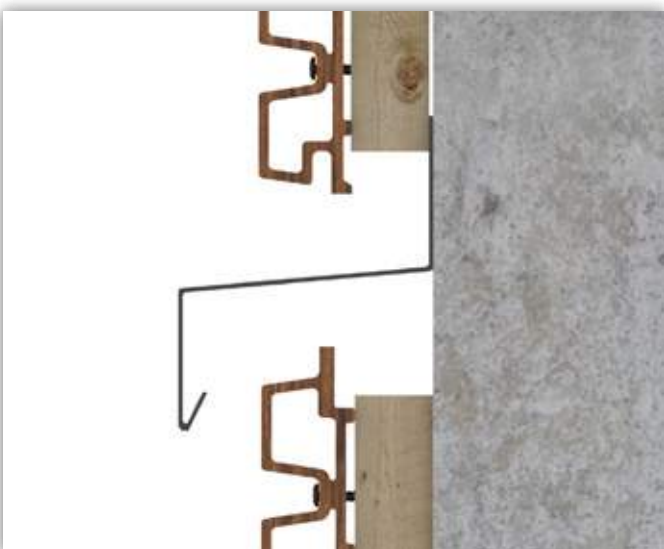



### 3 - POSE HORIZONTALE SUR TOUS SUPPORTS WEO® 35

#### 3.9 - ABOUT DE BARDAGE

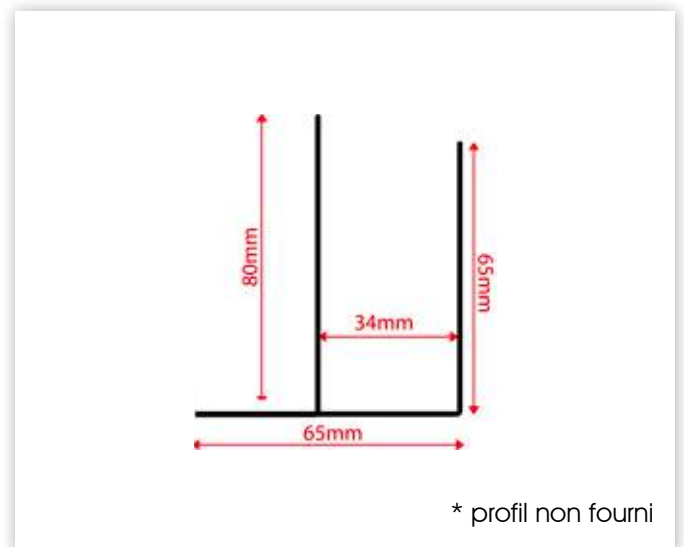
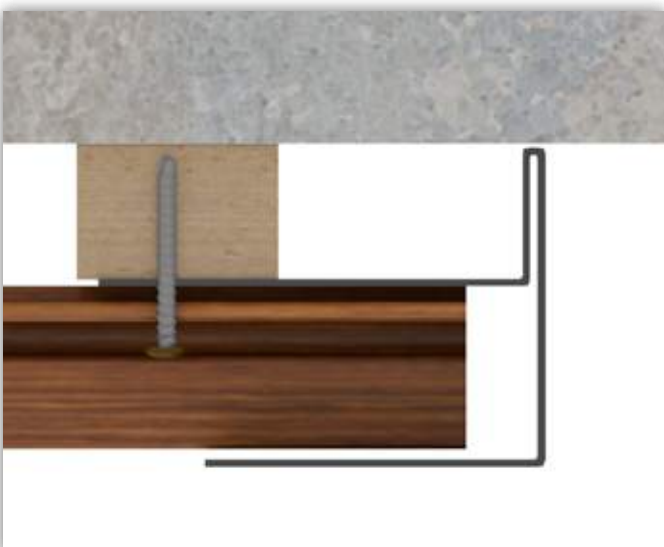

### 3 - POSE HORIZONTALE SUR TOUS SUPPORTS WEO® 35

#### 3.10 - JOINT DE DILATATION VERTICAL

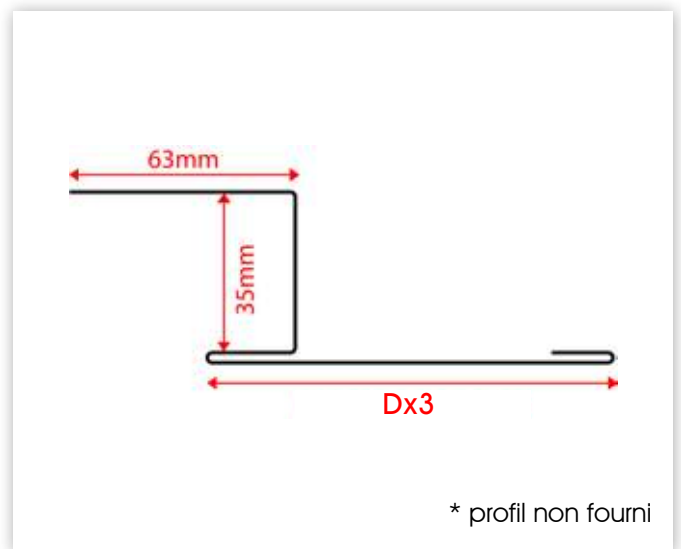
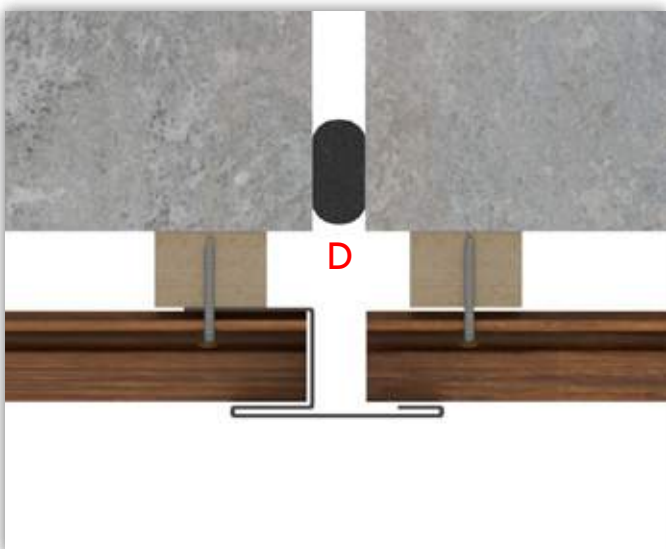
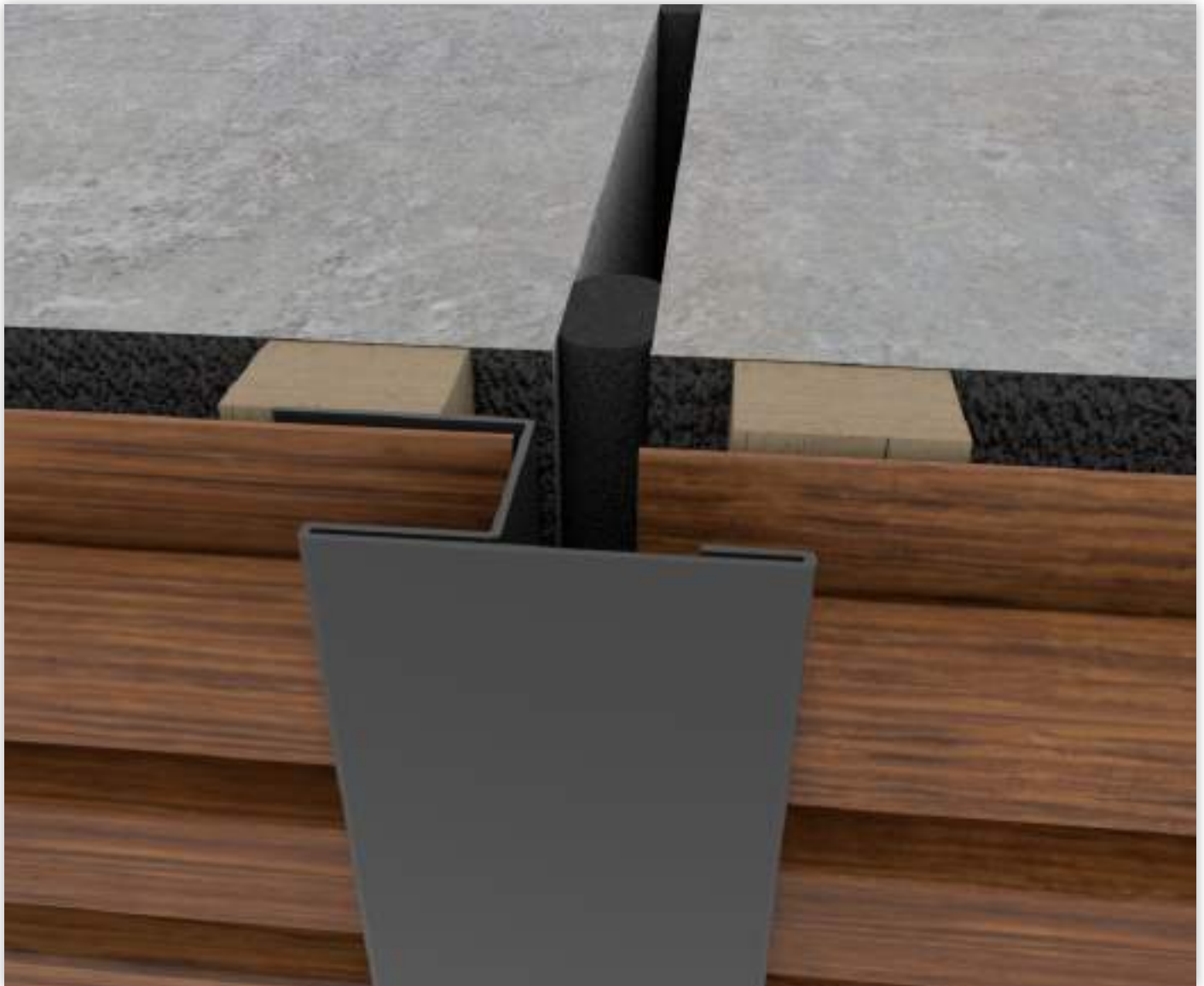

### 3 - POSE HORIZONTALE SUR TOUS SUPPORTS WEO® 35

#### 3.11 - REMPLACEMENT DE LAME

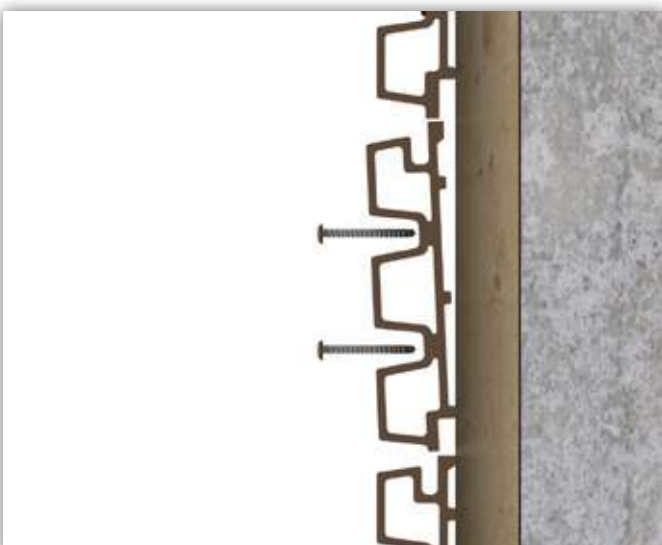
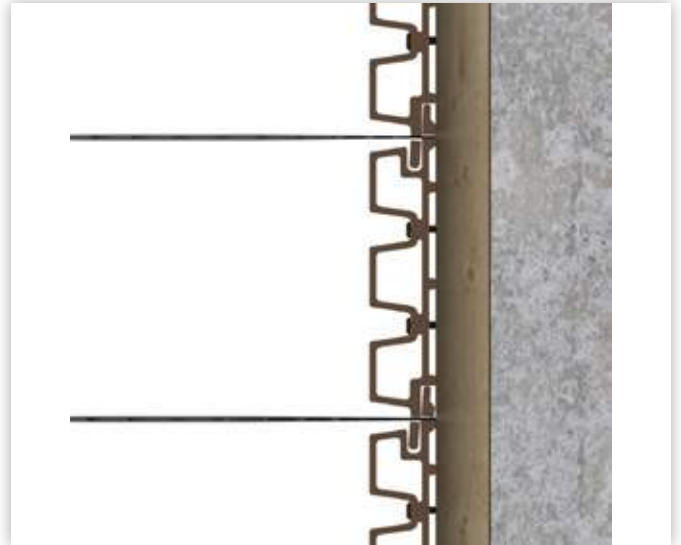



## 4 - POSE SUR CONSTRUCTION OSSATURE BOIS WEO® 35

### 4.1 - POSE HORIZONTALE

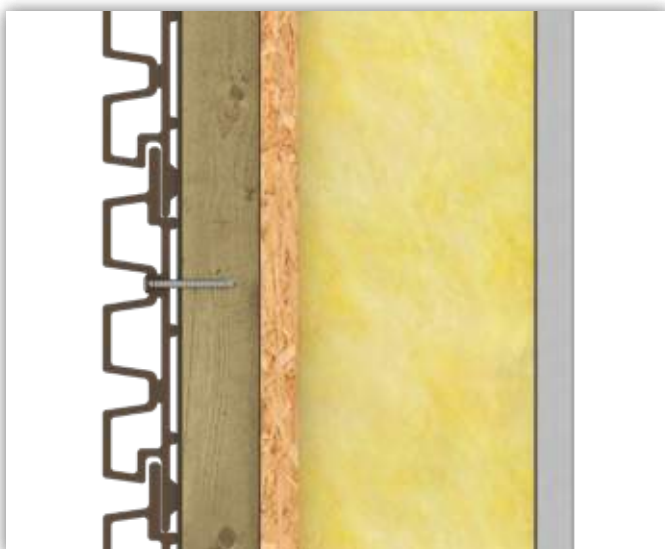
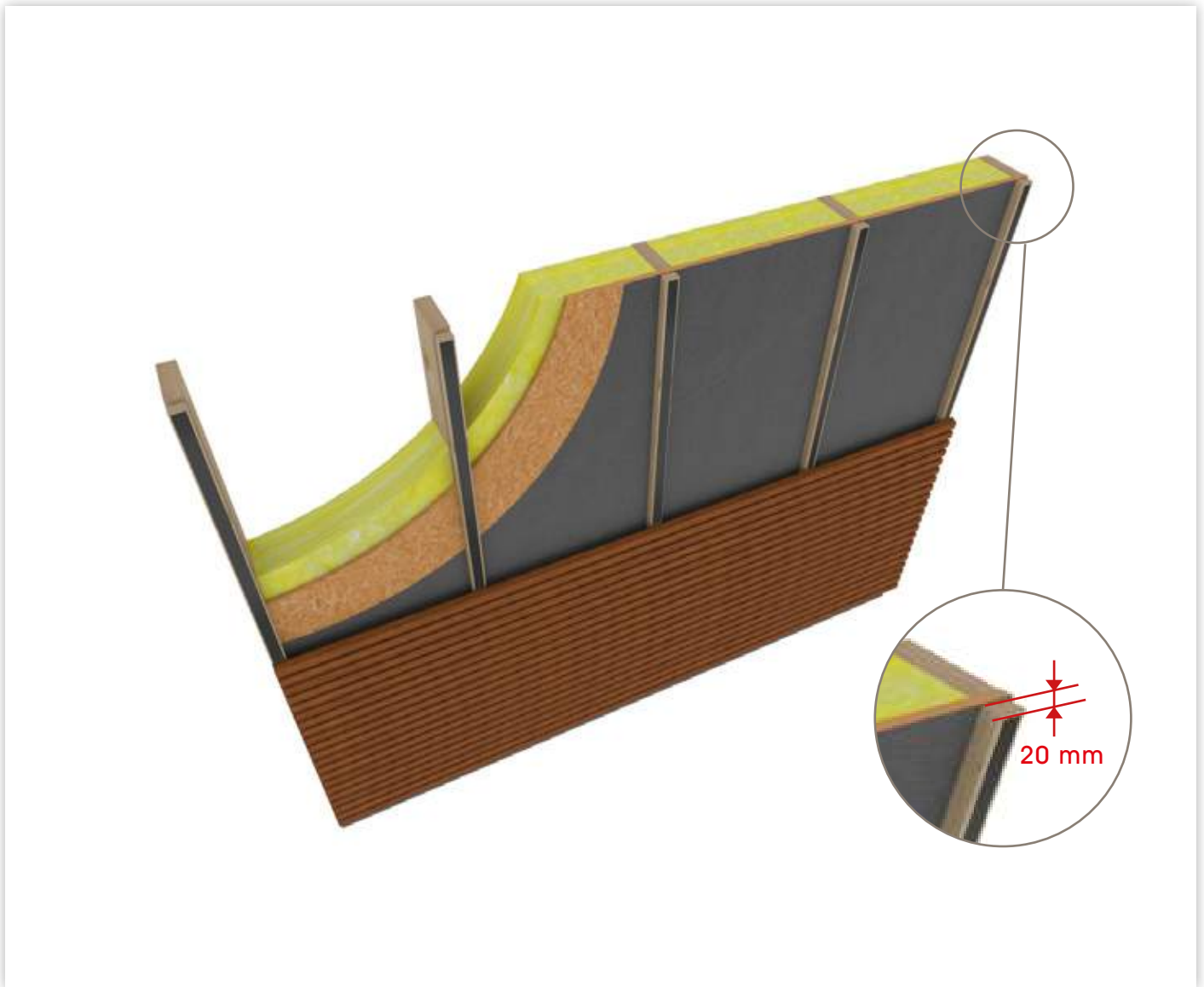



## 5 - POSE SUR OSSATURE METALLIQUE WEO® 35

### 5.1 - POSE HORIZONTALE

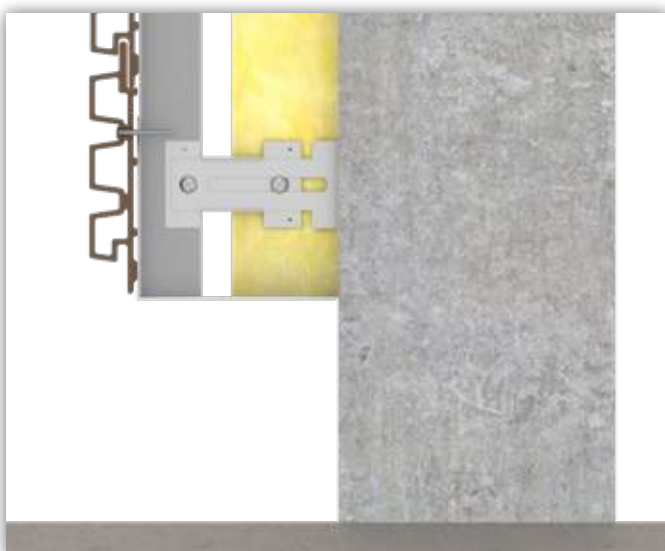
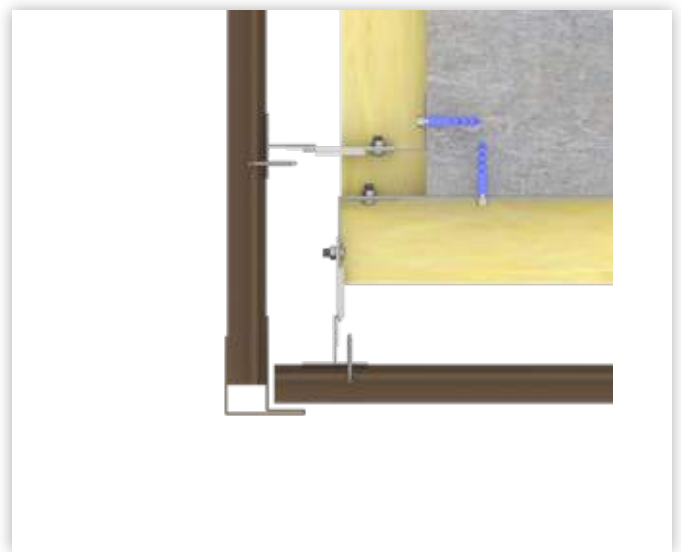
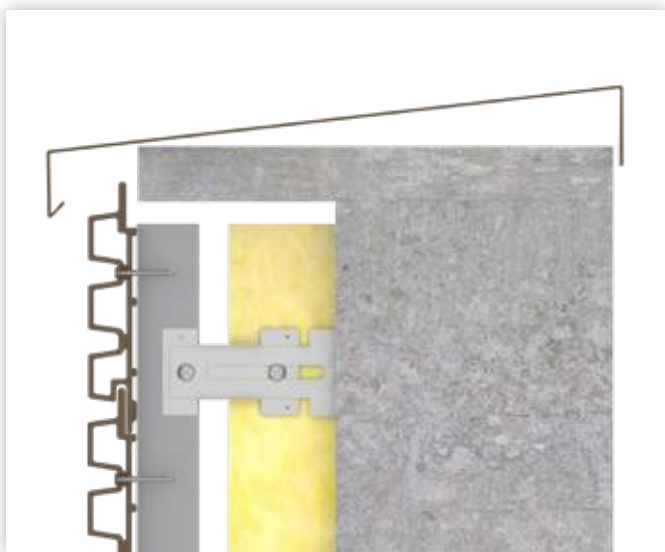
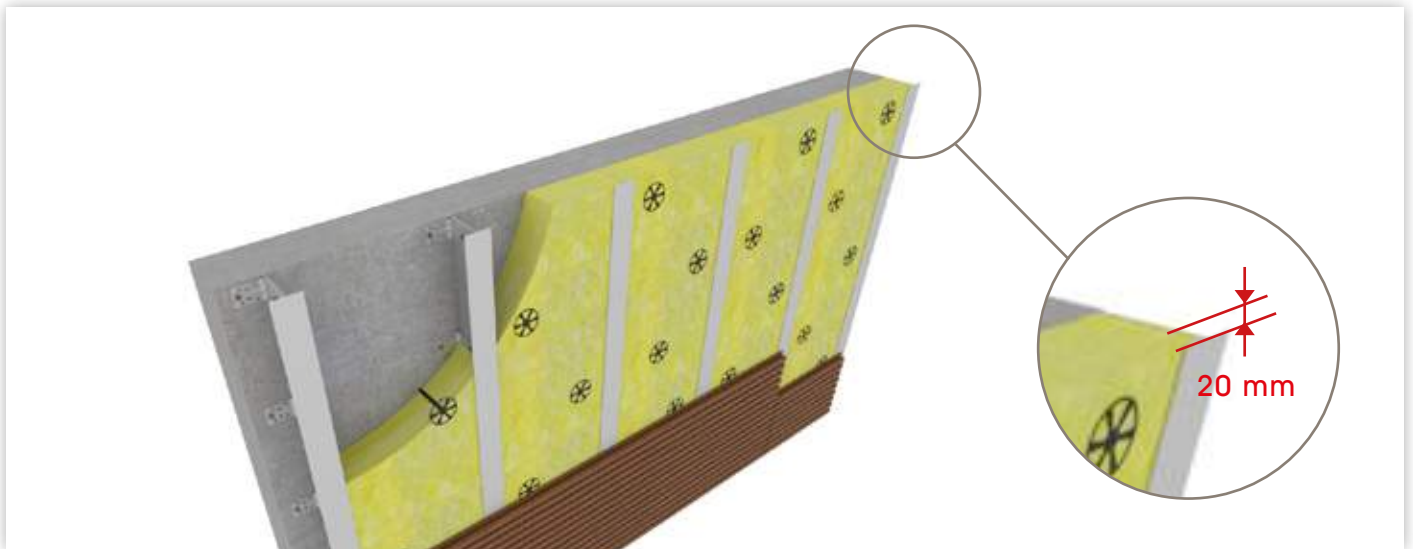

# 5 - POSE SUR OSSATURE METALLIQUE WEO® 35

## 5.2 - POSE VERTICALE

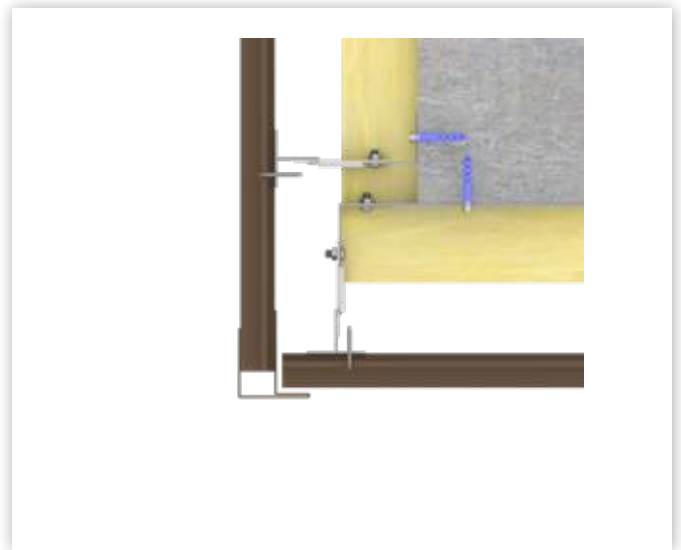
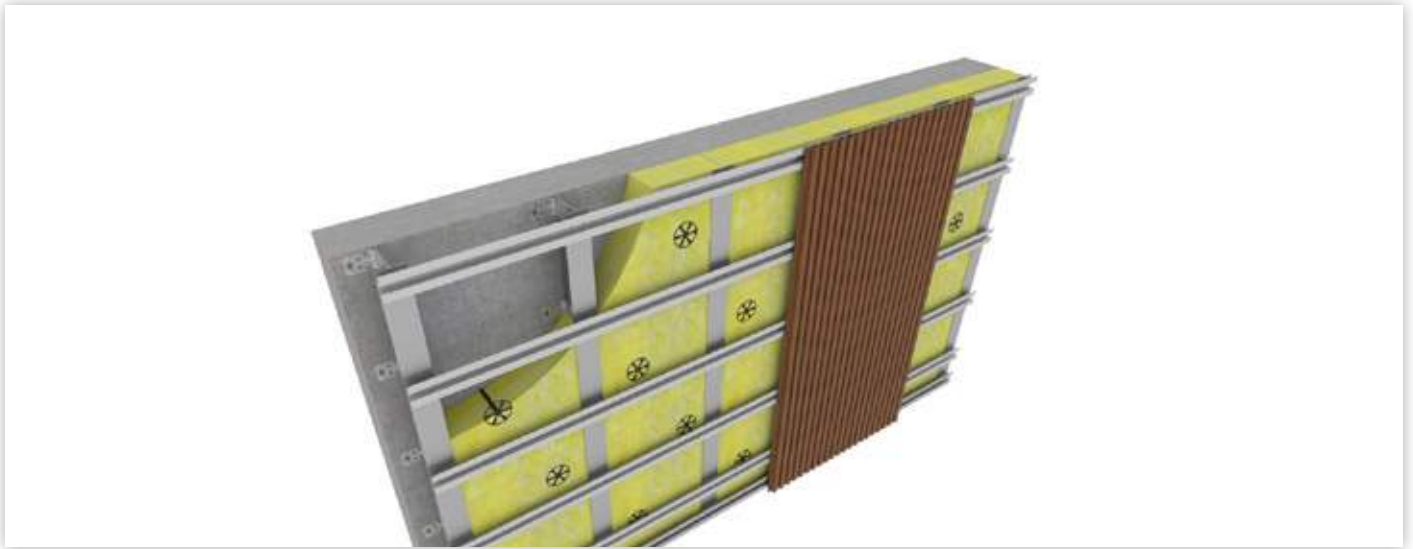

6 - POSE BARDAGE WE0® 60

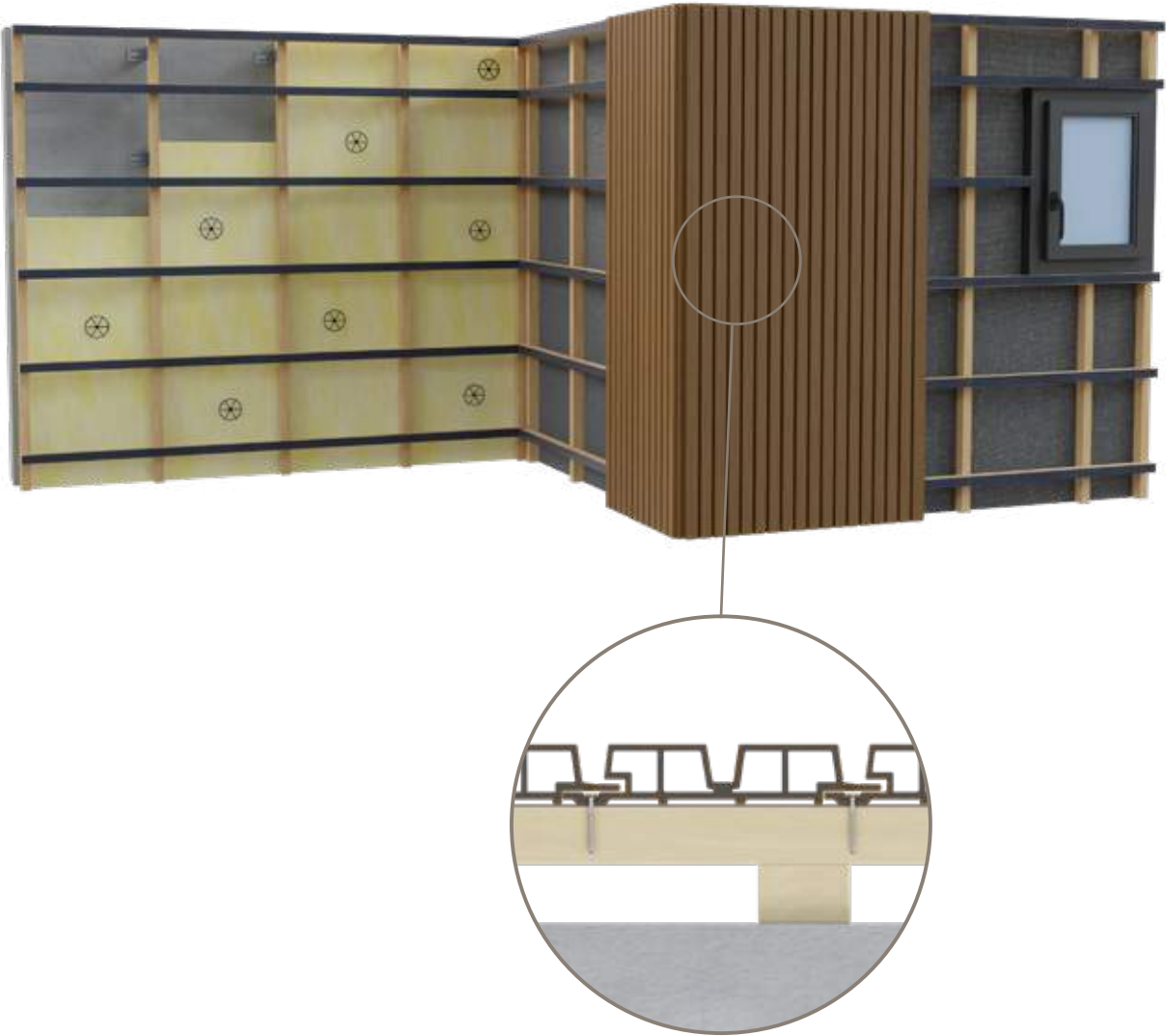

## 6 - POSE BARDAGE WE0® 60

### 6.1 - PIED DE MUR ET ACROTÈRE POSE VERTICALE



### 6.1.1 - PIED DE MUR ET ACROTÈRE POSE HORIZONTALE

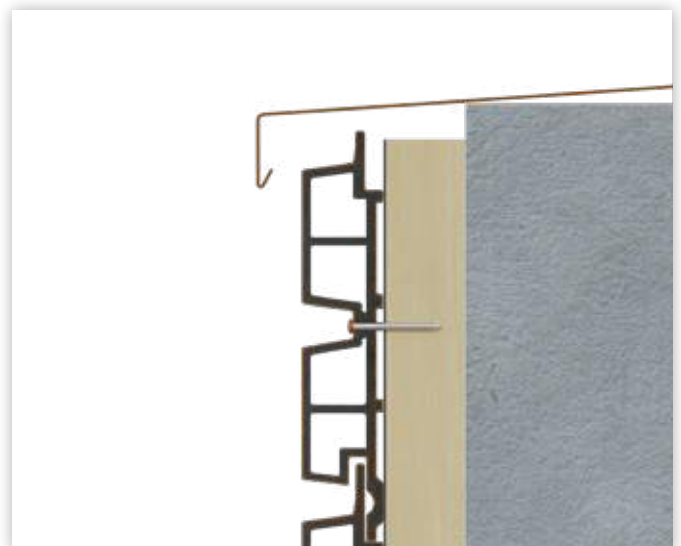
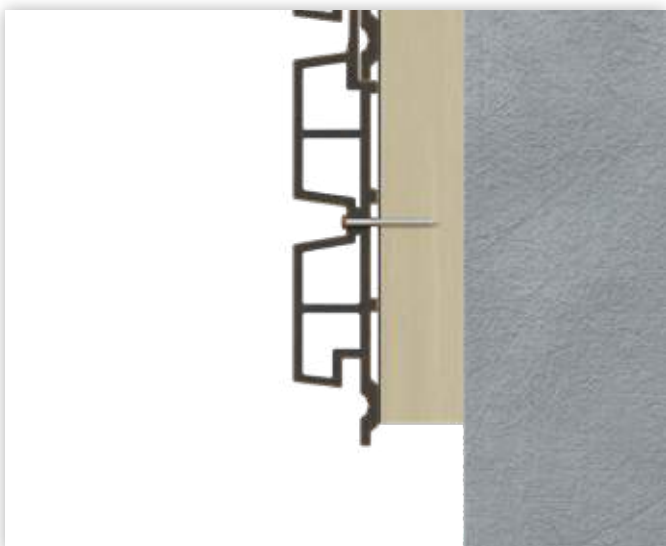



## 6 - POSE BARDAGE WE0® 60

### 6.2 - REMPLACEMENT DE LAME

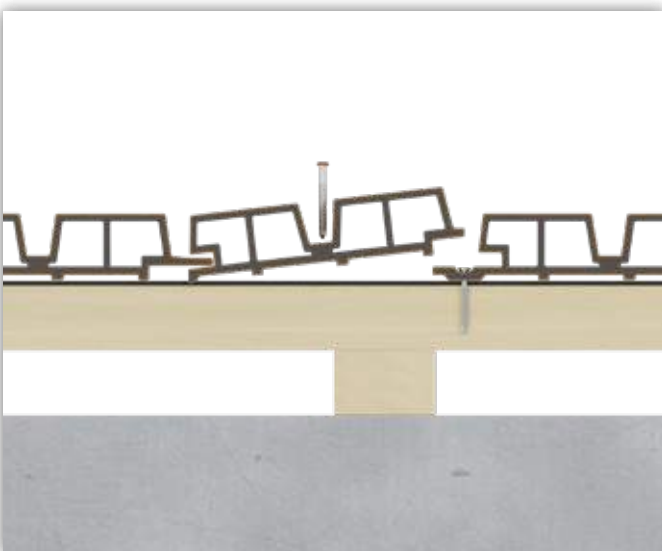
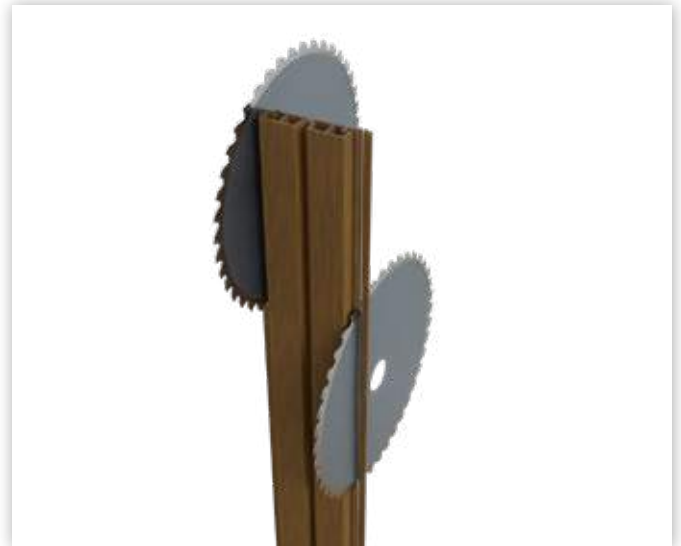
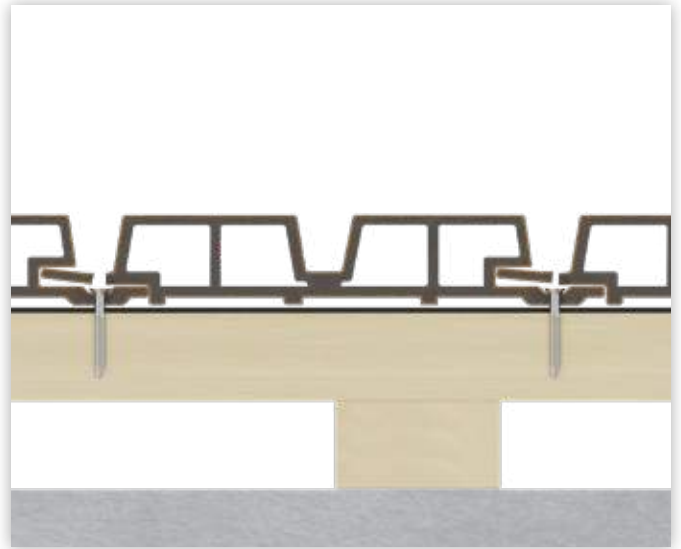

---

## 6 - POSE BARDAGE WE0® 60

*Compatible mix Weo® 35 / Weo® 60*

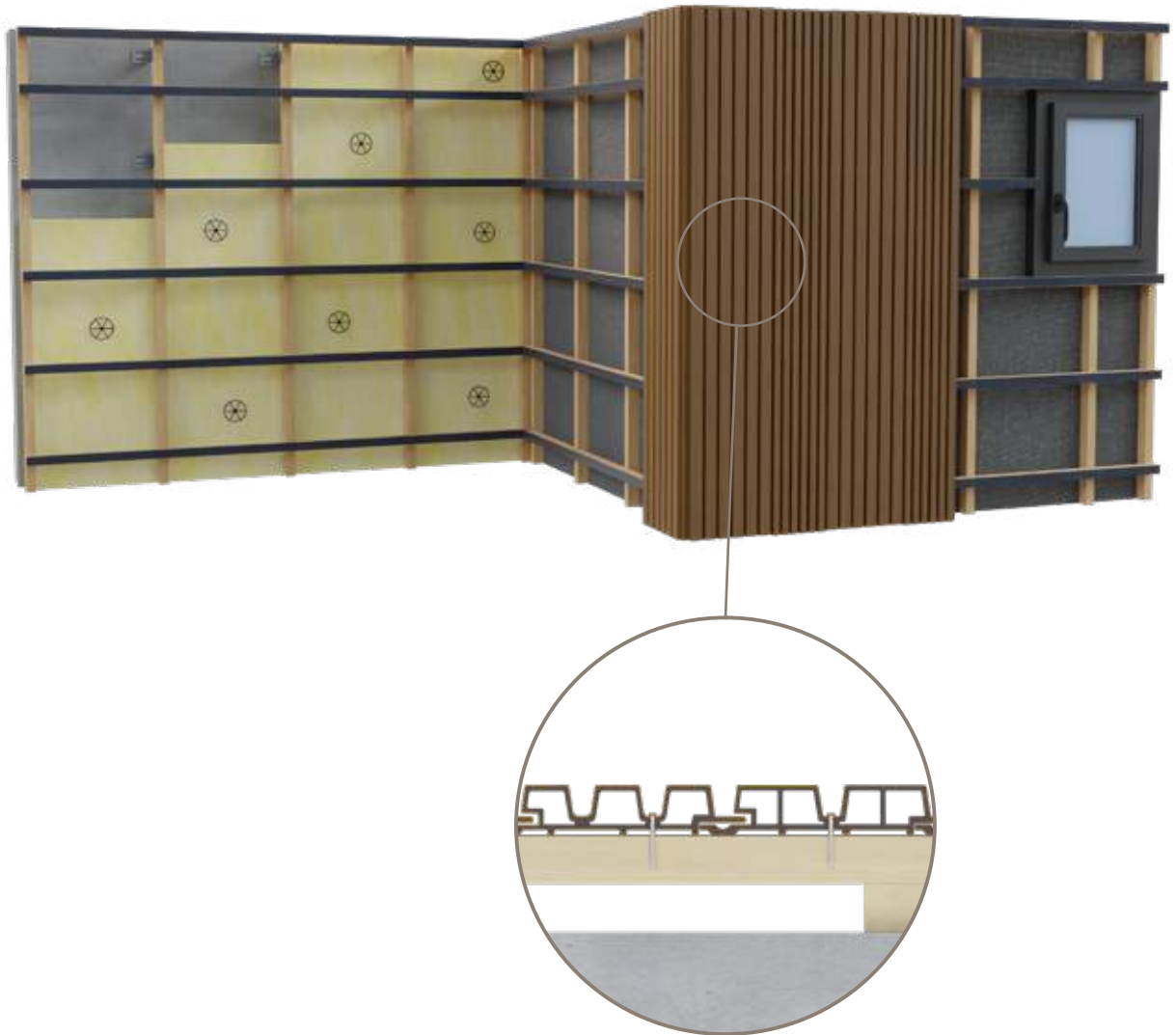



A series of 16 horizontal black lines spanning the width of the page, providing a structured area for writing or drawing. The lines are evenly spaced and extend from the left margin to the right edge.

**Fiberdeck<sup>®</sup>**

[fiberdeck.fr](http://fiberdeck.fr)